

OPERATOR'S MANUAL



CADD  Prizm[®]

PCS / Pain Control System

Model 6100 and 6101 Ambulatory Infusion Pump

This manual concerns **only** the CADD-Prizm® PCS (Pain Control System) Model 6100 and 6101 ambulatory infusion pumps. This pump can be programmed to deliver medication at a constant rate and/or allow delivery of a bolus dose at a specified time interval. This manual is intended for clinician use only. Do not permit patients to have access to this manual. The pump has three security levels designed to limit patient access. Do not disclose the pump's security codes or any other information that would allow inappropriate access to programming and operating functions.

The issue date of this Operator's Manual is included for the clinician's information. In the event one year has elapsed between the issue date and product use, the clinician should contact Smiths Medical MD, Inc. to see if a later revision of this manual is available.

Technical Assistance

If you have comments or questions concerning the operation of the CADD-Prizm® PCS pump, please call the number given below. When calling, please specify the pump's software module. This information is located in the pump's start-up screen.

Our staff at Smiths Medical MD is available to help clinicians twenty-four hours a day with the programming and operation of the CADD-Prizm® PCS infusion system.

Smiths Medical MD, Inc.
1265 Grey Fox Road
St. Paul, Minnesota 55112 U.S.A.
1 800.426.2448
+1 651.633.2556
www.smiths-medical.com

Read this entire Operator's Manual before operating the CADD-Prizm® PCS ambulatory infusion pump.

Failure to properly follow warnings, cautions, and instructions could result in death or serious injury to the patient.

WARNINGS

- This Operator's Manual should be used by clinicians only. Do not permit patients to have access to this manual, as the information contained would allow the patient complete access to all programming and operating functions. Improper programming could result in death or serious injury to the patient.
- For those patients who are likely to be adversely affected by unintended operations and failures, including interrupted medication or fluid delivery from the device, close supervision and provision for immediate corrective action should be provided.
- If the pump is used to deliver life-sustaining medication, an additional pump must be available.
- The pump is not to be used for delivery of blood or cellular blood products.
- If the pump is dropped or hit, inspect the pump for damage. Do not use a pump that is damaged or is not functioning properly. Contact Customer Service to return a pump for service.
- Use of a syringe with the CADD™ Administration Set may result in UNDER-DELIVERY of medication. Syringe function can be adversely affected by variations in plunger dimension and lubricity, which can result in greater force required to move the syringe plunger. A syringe plunger will lose lubrication as it ages and, as a result, the amount of under-delivery will increase which could on occasion, be significant. Therefore, the type of medication and delivery accuracy required must be considered when using a syringe with the CADD® pump.

Clinicians must regularly compare the volume remaining in the syringe to the pump's displayed values such as RES VOL and GIVEN in order to determine whether under-delivery of medication is occurring and if necessary, take appropriate action.

- System delivery inaccuracies may occur as a result of back pressure or fluid resistance, which depends upon drug viscosity, catheter size, and extension set tubing (for example, microbore tubing).

- Do not administer drugs to the epidural space or subarachnoid space unless the drug is indicated for those spaces.
- To prevent the infusion of drugs that are not indicated for epidural space or subarachnoid space infusion, DO NOT use administration sets that incorporate injection sites.
- If a Medication Cassette Reservoir, CADD™ Extension Set or CADD™ Administration Set is used for epidural space or subarachnoid space drug delivery, it is strongly recommended that it be clearly differentiated from those used for other routes of infusion, for example, by color coding, or other means of identification.
- When the Air Detector is not installed, or is installed but turned off, the pump will not detect air in the fluid path. It is recommended that you periodically inspect the fluid path and remove any air to prevent air embolism.
- Follow the Instructions for Use provided with the Medication Cassette Reservoir and CADD™ Extension Set, or the CADD™ Administration Set, paying particular attention to all warnings and cautions associated with their use.
- When the Upstream Occlusion Sensor is turned Off, the pump will not detect occlusions upstream (between pump and fluid container). It is recommended that you periodically inspect the fluid path for kinks, a closed clamp, or other upstream obstructions. Upstream occlusions may result in under- or non-delivery of medications.
- Do not disclose to the patient the pump's security codes or any other information that would allow the patient complete access to all programming and operating functions.
- Ensure that the $\pm 6\%$ System Delivery Accuracy specification is taken into account when programming the pump and/or filling the Medication Cassette Reservoir. Failure to do so may result in medication in the reservoir becoming depleted sooner than expected.
- Do not use rechargeable NiCad or nickel metal hydride (NiMH) batteries. Do not use carbon zinc ("heavy duty") batteries. They do not provide sufficient power for the pump to operate properly.
- Always have new batteries available for replacement. If power is lost, non-delivery of drug will occur.

- There is no pump alarm to alert users that a battery has not been properly installed or has become dislodged. An improperly installed or dislodged battery could result in loss of power and non-delivery of drug.
- If the pump is dropped or hit, the battery door may become broken or damaged. Do not use the pump if the battery door is damaged because the battery will not be properly secured; this may result in loss of power or non-delivery of drug.
- When you enter a new Demand Dose Lockout time, any lockout time in effect will be cleared. A Demand Dose could be requested and delivered immediately upon starting the pump, resulting in over-delivery.
- When you enter a new Max Doses per Hour value, any lockout time in effect will be cleared. A Demand Dose could be requested and delivered immediately upon starting the pump, resulting in over-delivery.
- Exercise care when using the Clinician Bolus function. Since there are no limits on the frequency of delivering a bolus, and since the amount of the bolus can be set as high as 20 ml (or the mg or mcg equivalent), you should not permit the patient to become familiar with the procedure for giving a Clinician Bolus.
- To prevent the patient from accessing the Clinician Bolus function, do not let the patient know the Clinician Bolus code.
- Always close the fluid path tubing with the clamp before removing the cassette from the pump to prevent unregulated gravity infusion.
- Attach the cassette properly. A detached or improperly attached cassette could result in unregulated gravity infusion of medication from the fluid container or a reflux of blood.

If you are using a Deltec administration set or medication cassette reservoir that does not have the flow stop feature (reorder number does not start with 21-73xx): you must use a CADD™ Extension Set with anti-siphon valve or a CADD™ Administration Set with either an integral or add-on anti-siphon valve to protect against unregulated gravity infusion that can result from an improperly attached cassette.

- Do not prime the fluid path with the tubing connected to a patient as this could result in over-delivery of medication or air embolism.
- Ensure that the entire fluid path is free of all air bubbles before connecting to the patient to prevent air embolism.
- If Demand Doses are currently locked out, changing the Date and/or Time

will cancel the lockout period. This will allow a Demand Dose to be requested and delivered as soon as you restart the pump, resulting in over-delivery.

CAUTIONS

- Do not operate the pump at temperatures below +2°C (36°F) or above 40°C (104°F).
- Do not store the pump at temperatures below -20°C (-4°F) or above 60°C (140°F). Do not store the pump with a Medication Cassette Reservoir or CADD™ Administration Set attached.
- Do not expose the pump to humidity levels below 10% or above 90% relative humidity.
- Do not store the pump for prolonged periods with the battery installed. Battery leakage could damage the pump.
- If you are using a Medication Cassette Reservoir in which the medication is frozen, thaw at room temperature only. *Do not heat in a microwave oven* as this may damage the product and cause leakage.
- Do not immerse the pump in cleaning fluid or water. Do not allow solution to soak into the pump, accumulate on the keypad, or enter the battery compartment, Data In/Out jack, Power jack or Air Detector port area. Moisture build-up inside the pump may damage the pump.
- Do not clean the pump with acetone, other plastic solvents, or abrasive cleaners, as damage to the pump may occur.
- Do not expose the pump to therapeutic levels of ionizing radiation as permanent damage to the pump's electronic circuitry may occur. The best procedure to follow is to remove the pump from the patient during therapeutic radiation sessions. If the pump must remain in the vicinity during a therapy session, it should be shielded, and its ability to function properly should be confirmed following treatment.
- Do not expose the pump directly to ultrasound, as permanent damage to the pump's electronic circuitry may occur.
- Do not use the pump in the vicinity of magnetic resonance imaging (MRI) equipment as magnetic fields may adversely affect the operation of the pump. Remove the pump from the patient during MRI procedures and keep it at a safe distance from magnetic energy.
- Do not use the pump near ECG equipment as the pump may interfere with

the operation of the equipment. Monitor ECG equipment carefully when using this pump.

- Do not sterilize the pump.
- Do not use the pump in the presence of flammable anesthetics or explosive gases.
- Use only Smiths Medical MD accessories as using other brands may adversely affect the operation of the pump.
- Check appropriate medication stability for time and temperature to assure stability with actual pump delivery conditions.

SYMBOLS



Collect Separately



CAUTION: Federal (USA) law restricts this device to sale by or on the order of a physician.

Table of Contents

Warnings	iii
Cautions	vi
Section 1: General Description	1
Introduction	1
Indications	1
Epidural/Subarachnoid Administration	1
Pump Diagram	3
Description of Keys, Display and Features	4
The Main Screen	8
Getting Help Using the (?) Key	9
Lock Levels	10
AutoLock	10
Security Codes	10
Customizing the Security Codes	10
Lock Level Table	11
Section 2: Pump Setup and Programming	13
Installing the Battery	13
Watching Power Up	15
Changing to Lock Level 0 (LL0)	16
Programming the Pump: General Instructions	17
PCA Delivery Method	18
PCA Programming Screens	19
PCA Programming Example	24
Removing a Cassette	30
Attaching a Cassette	31
Priming the Tubing and Connecting to the Patient	34
Inserting the Tubing into the Air Detector	36
Setting the Lock Level for the Patient	38
Starting the Pump	39
Programming with Upper Limits, Adjusting Doses in Lock Level 1	40
Section 3: Operating the Pump	41
Stopping the Pump	41
Starting the Pump	41
Starting a Clinician Bolus	43
Starting a Demand Dose	45
Stopping a Demand Dose or Clinician Bolus	46

Resetting the Reservoir Volume	47
Section 4: Options	49
Overview: Accessing Options	49
Prime	50
Extended History, Viewing	51
AutoLock	53
Time	54
Date	55
Air Detector On/Off	56
Event Log, Viewing	57
Section 5: Biomed Toolbox	59
Overview: Accessing the Biomed Toolbox	59
Micrograms On/Off	60
Custom Concentrations	60
Extended History On/Off	62
Max Doses Per Hour On/Off	62
PM (Preventive Maintenance) Reminder	63
Custom Lock Level Code	63
Date Format	64
Power Source Status Display	65
Upstream Sensor On/Off (Model 6101 only)	65
Air Detector Requirement	66
Section 6: Reference & Troubleshooting	67
Troubleshooting	67
Alarms and Messages, Alphabetical List	69
Cleaning the Pump and Accessories	77
Cleaning the Battery Contacts	78
Exposure to Radiation or Magnetic Resonance Imaging (MRI)	79
Continuous Rate Scroll Ranges	80
Demand Dose, Clinician Bolus Scroll Ranges: Milliliters	80
Demand Dose, Clinician Bolus Scroll Ranges: Milligrams	81
Demand Dose, Clinician Bolus Scroll Ranges: Micrograms	82
Military Time Conversion Chart	83
Specifications (Nominal)	84
Printing Reports	87
Index	88
Limited Warranty	91

Section 1: General Description

Introduction

The CADD-Prizm® PCS (Pain Control System) ambulatory infusion system provides measured drug therapy to patients in hospital or outpatient settings. Therapy should always be overseen by a physician or a certified, licensed healthcare professional. As appropriate, the patient should be instructed in using the pump.

Indications

The CADD-Prizm® PCS pump is indicated for intravenous, subcutaneous, epidural space, or subarachnoid space infusion. The pump is intended for therapies that require a continuous rate of infusion, patient-controlled demand doses, or both (such as patient-controlled analgesia).

Epidural/Subarachnoid Administration

The selected drug must be used in accordance with the indications included in the package insert accompanying the drug. Administration of any drug by this pump is limited by any warnings, precautions, or contraindications in the drug labeling.

Analgesics

Administration of analgesics to the epidural space is limited to use with indwelling catheters specifically indicated for either short- or long-term drug delivery.

Administration of analgesics to the subarachnoid space is limited to use with indwelling catheters specifically indicated for short-term drug delivery.

Anesthetics

Administration of anesthetics to the epidural space is limited to use with indwelling catheters specifically indicated for short-term drug delivery.

WARNING:

- Do not administer drugs to the epidural space or subarachnoid space unless the drug is indicated for administration to those spaces. Drugs not intended for epidural or subarachnoid space infusion could result in death or serious injury to the patient.
 - To prevent the infusion of drugs that are not indicated for epidural space or subarachnoid space infusion, **DO NOT** use administration sets that incorporate injection sites. The inadvertent use of injection sites for infusion of such drugs may cause death or serious injury to the patient.
 - If a Medication Cassette Reservoir, CADD™ Extension Set or CADD™ Administration Set is used for epidural space or subarachnoid space drug delivery, it is strongly recommended that it be clearly differentiated from those used for other routes of infusion, for example, by color coding, or other means of identification. Drugs not intended for epidural or subarachnoid space infusion could result in death or serious injury to the patient.
-
-

Pump Diagram

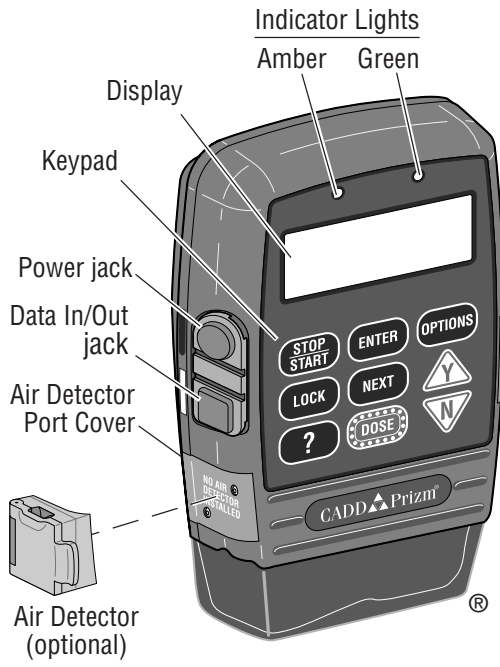

Front View

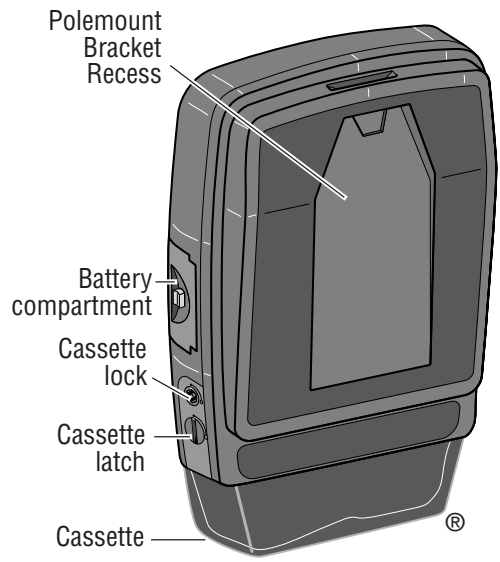

Rear View

Description of Keys, Display and Features

Indicator Lights

Green: The green light blinks approximately every 3 seconds when the pump is running and delivering fluid as programmed.





Amber: The amber light flashes when the pump is stopped or an alarm condition exists. It stays on continuously when the pump is inoperable. The display briefly describes the condition.

If both lights blink, delivery is still occurring but a condition exists of which you should be aware (for example, a low battery). Look at the display for a brief description of the condition.

Display with backlighting

The liquid crystal display (LCD) shows programming information and messages. Backlighting helps keep the display visible in low light.

After a period of no key presses, backlighting turns off and the display blanks to save battery power (except during an alarm or when an external power source is in use). Press any key to turn the display back on.

NOTE: If you press , the display will reappear with a message asking if you wish to start or stop the pump; press  or . Do not use  to turn the display back on; this may deliver an inadvertent dose.

Keypad

The keys on the keypad are described below. A key beeps when pressed if it is operable in the current lock level.



starts and stops pump delivery.



is used to view or change the pump's current lock level. Lock levels are used to limit patient access to certain programming and operating functions. (See Lock Levels, this section.) This key is also used to access the Clinician Bolus while the pump is running.



is the "Help" key. It is used to display help for a screen or an alarm message. (See Getting Help, this section.)



is used to enter, or save, a new value in the pump's memory when programming new doses or new pump settings. It is also used to select an item from the Options Menu (Section 4) or Biomed Toolbox Menu (Section 5).



is used to move from one programming screen to the next without

changing the setting or value displayed. It is also used to return from the Biomed Toolbox Menu to the Options Menu, or from the Options Menu to the main screen. (See Sections 4 and 5.)



allows the patient to deliver a programmed amount of medication upon request.



is used to access the Options Menu, which contains such features as time, date, and the Event Log. (See Section 4, Options.)



allows you to answer “yes” to a question on the pump’s display, “scroll up” or increase a value (for example, a dose amount), or scroll through items on a menu.



allows you to answer “no” to a question on the pump’s display, “scroll down” or decrease a value, scroll through items on a menu, or cancel printing.

Power jack

You may plug a CADD™ External Power Source (EPS) system power pack or an AC Adapter into the Power jack as an alternate source of power.

Data In/Out jack

The Data In/Out jack is used for attaching the following accessories:

- **Interface Cable** for printing reports
- **Remote Dose Cord** for remote operation of the dose key
- **Modem Cable** for communications

For more information on the Remote Dose Cord, printing or communications, see the instructions for use provided with those products.

Air Detector Port Cover

This encloses the Air Detector port when the Air Detector is not attached.

Air Detector accessory (optional)

The Air Detector attaches to the pump in the area shown in the diagram. If air is detected in the part of the tubing that passes through the Air Detector, an alarm sounds and delivery stops. (See Section 6 for Air Detector specifications.) The pump may be customized to require an Air Detector. (See Section 5, Biomed Toolbox.) If an Air Detector is attached but not required, it may be turned off.

WARNING: When the Air Detector is not installed, or is installed but turned

off, the pump will not detect air in the fluid path. It is recommended that you periodically inspect the fluid path and remove any air to prevent air embolism. Air embolism could result in death or serious injury to the patient.

Cassette

The cassette is the part of the Medication Cassette Reservoir or CADD™ Administration Set that attaches to the bottom of the pump. The following single-use products are compatible with the CADD-Prizm® pump:

- Medication Cassette Reservoir (50 or 100 ml), used with a CADD™ Extension Set
 - CADD™ Administration Set
-
-

WARNING: Follow the Instructions for Use provided with the Medication Cassette Reservoir and CADD™ Extension Set, or the CADD™ Administration Set, paying particular attention to all warnings and cautions associated with their use. Incorrect preparation and/or use of these products could result in serious patient injury or death.

Polemount Bracket recess

The optional Polemount Bracket slides into the recess on the back of the pump, allowing you to attach the pump to an IV pole.

Battery compartment

The 9 volt battery fits into this compartment. The 9 volt battery serves as the primary source of power, or as a backup when an EPS System power pack or AC Adapter is in use.

Cassette latch

This attaches the cassette to the pump. The pump detects whether the cassette is latched properly. Delivery will stop and an alarm will occur if the cassette becomes unlatched.

Cassette lock

This allows you to secure the cassette to the pump using the key provided. The cassette must be latched before it can be locked. The cassette must be locked onto the pump or the pump will not run.

Other Features Not Shown

Downstream Occlusion Sensor: The pump contains a downstream occlusion sensor. When a downstream occlusion between the pump and patient access site is detected, an alarm will sound, delivery will stop, and the display will show “High Pressure.”

Upstream Occlusion Sensor: (Model 6101 only) The pump contains an upstream occlusion sensor. This feature may be turned on or off (see Section 5, Biomed Toolbox). When the sensor is turned on, and an upstream occlusion (between pump and fluid container) is detected, an alarm will sound, delivery will stop, and the display will show “Upstream Occlusion.”

WARNING: When the Upstream Occlusion Sensor is turned Off, the pump will not detect occlusions upstream (between pump and fluid container). It is recommended that you periodically inspect the fluid path for kinks, a closed clamp, or other upstream obstructions. Upstream occlusions may result in under- or non-delivery of medications to the patient. If undetected, these occlusions could lead to death or serious injury to the patient.

Reservoir Volume Alarm: Reservoir Volume is a feature that indicates when the fluid in the fluid container is low or depleted. Each time you change the fluid container, you may reset the Reservoir Volume to the originally programmed volume. Then, as medication is delivered, the Reservoir Volume automatically decreases. When the pump calculates that 5 ml remain in the fluid container, beeps sound and “Reservoir Volume Low” appears. This alarm recurs at every subsequent decrease of 1 ml until the Reservoir Volume reaches 0 ml, at which point the pump stops.

The Main Screen

The main screen is the starting point for programming or viewing the pump's settings. The following information may be displayed:

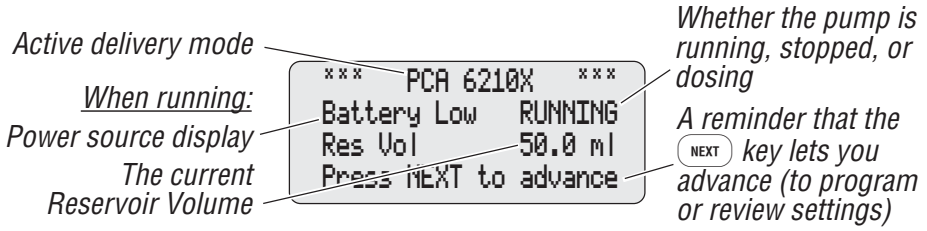

If no keys are pressed for a period of time (2 minutes when the pump is stopped, 1 minute when running), the display reverts to the main screen. When the 9 volt battery is low, "Battery Low" appears on the main screen. You can configure the pump so the main screen always displays the type of power source in use. (See Power Source Display, Section 5.)

Getting Help Using the **(?)** Key

If you have a question about a screen, press the **(?)** key for help. A description of the screen will appear along with instructions for pump operations you may be trying to perform. The following is an example of help for the **Reservoir Volume** screen:

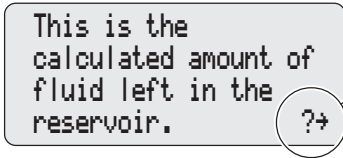

This is the
calculated amount of
fluid left in the
reservoir. **(?)→**

*The symbol in the lower right corner means there are additional help screens. Press the **(?)** key again to see the next help screen.*

- To page through all the help screens, press **(?)** repeatedly. The original screen will reappear when no further help is available.
- To exit help, press any key (other than the **(?)** key). This will bring you back to the original screen.
- If a help screen tells you to press a certain key, first exit help, then press that key.

Help screens are lock level dependent. If the pump's current lock level prevents access to a certain function, the function will not be described in the help screens.

Lock Levels

Lock levels are used to limit patient access to certain programming and operating functions. The table on the next page lists the functions that are accessible in Lock Level 0 (LL0), Lock Level 1 (LL1), and Lock Level 2 (LL2). When a function is accessible, the key associated with the function beeps when pressed. If a function is not accessible, the pump ignores the key press and a beep does not sound. Section 2, Pump Setup and Programming, describes how to change the lock level.

AutoLock

AutoLock is one of the Options. This feature automatically changes the lock level from LL0 to LL1 or LL2 when the pump is started (instead of requiring you to manually change the lock level before giving the pump to the patient). See Section 4 for more information on using AutoLock.

Security Codes

The following security codes are preset by the manufacturer for the clinician's use:

**** Text omitted from Online version ****

WARNING: Do not disclose to the patient the pump's security codes or any other information that would allow the patient complete access to all programming and operating functions. Improper programming could result in death or serious injury to the patient.

Customizing the Security Codes

If it becomes necessary to change the Lock Level Code and Biomed Toolbox Code to ensure that a patient will be unable to access these features, you may customize the Lock Level Code in the Biomed Toolbox. (See Section 5.) Customizing the Lock Level Code will not affect the Clinician Bolus Code.

Lock Level Table

This table lists the operations that are accessible in each lock level while the pump is stopped and running. LL0 permits complete access to all programming and operating functions. LL1 permits limited control of pump programming and operations. LL2 permits only minimal control of the pump.

Pump Operations and Programming	Stopped			Running
	LL0	LL1	LL2	Any Lock Level
Stop/Start the pump	Yes	Yes	Yes	Yes
View Help screens	Yes	Yes	Yes	Yes
Print	Yes	Yes	Yes	Yes
Reset Reservoir Volume	Yes	Yes	Yes	<i>No</i>
Change the lock level	Yes, w/code	Yes, w/code	Yes, w/code	<i>No</i>
Start a Demand Dose	<i>No</i>	<i>No</i>	<i>No</i>	Yes
Start a Clinician Bolus	<i>No</i>	<i>No</i>	<i>No</i>	Yes, w/code
Change Units	Yes	<i>No</i>	<i>No</i>	<i>No</i>
Change Concentration	Yes	<i>No</i>	<i>No</i>	<i>No</i>
Change Continuous Rate	Yes	Up to LL0 value	<i>No</i>	<i>No</i>
Change Demand Dose	Yes	Up to LL0 value	<i>No</i>	<i>No</i>
Clear Dose Counters	Yes	Yes	<i>No</i>	<i>No</i>
Clear Given amount	Yes	Yes	<i>No</i>	<i>No</i>
Add New Patient Marker	Yes	<i>No</i>	<i>No</i>	<i>No</i>
Pump Options				
Prime	Yes	Yes	<i>No</i>	<i>No</i>
Extended History (view)	Yes	Yes	Yes	Yes
AutoLock	Yes	View only	View only	View only
Time	Yes	View only	View only	View only
Date	Yes	View only	View only	View only
Air Detector On/Off	Yes	View only	View Only	View Only
Event Log (view)	Yes	Yes	Yes	Yes
Biomed Toolbox	Yes, w/code	<i>No</i>	<i>No</i>	<i>No</i>

Section 1: General Description

Section 2: Pump Setup and Programming

Installing the Battery

Use a new, 9 volt alkaline or lithium battery such as the DURACELL® Alkaline MN 1604, the EVEREADY® ENERGIZER® Alkaline #522 or the ULTRA-LIFE® Lithium U9VL battery. The pump retains all programmed values while the battery is removed. If the pump is running, you may connect an external power source to keep the pump running for 3 minutes while you change the battery.

Dispose of used batteries in an environmentally safe manner, and according to any regulations which may apply.

WARNING:

- Do not use rechargeable NiCad or nickel metal hydride (NiMH) batteries. Do not use carbon zinc (“heavy duty”) batteries. They do not provide sufficient power for the pump to operate properly, which could result in death or serious injury to the patient.
 - Always have new batteries available for replacement. If power is lost, non-delivery of drug will occur and, depending on the type of drug being administered, could result in death or serious injury to the patient.
 - There is no pump alarm to alert users that a battery has not been properly installed or has become dislodged. An improperly installed or dislodged battery could result in loss of power and non-delivery of drug and, depending on the type of drug being administered, could result in death or serious injury to the patient.
 - If the pump is dropped or hit against a hard surface, the battery door may become broken or damaged. DO NOT USE the pump if it has been damaged in this way because the battery will not be properly secured; this may result in loss of power, non-delivery of drug, and, depending on the type of drug being administered, death or serious injury to the patient.
-
-

To install a battery

1. Make sure the pump is stopped. Press the button on the battery door and slide the battery door forward. Remove the used battery.

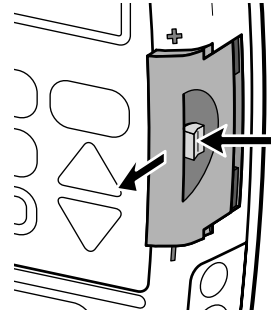

2. Match the + and – markings on the new battery with the markings on the pump. Insert the battery. The pump will beep if the battery is inserted correctly.
3. Replace the battery door. The pump will begin to power up.

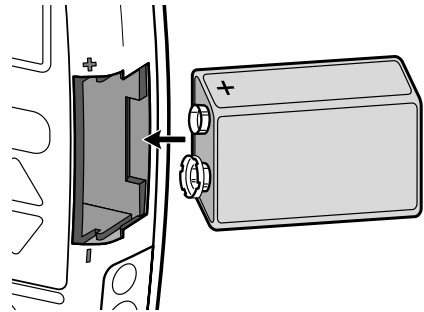

NOTE: If you put the battery in backwards, the display will remain blank. Reinsert the battery, making sure to match the + and – markings.

CAUTION: Do not store the pump for prolonged periods with the battery installed. Battery leakage could damage the pump.

NOTE:



- Battery life is dependent on the amount of medication delivered, delivery rate, battery age, temperature, frequent screen display and backlighting and frequent printing.
- The power of the battery will be quickly depleted at temperatures below +10°C (50°F).

Watching Power Up

When you install a battery, the pump will start its power up sequence during which it performs self-tests and displays programmed values. Watch for the following:

- Pump model number, last error code (“lec”) if any, and serial number (“sn”) will appear.
- The delivery mode contained in the pump and its software version will appear.
- The display will turn completely on. Look for any stripes, which would indicate a faulty display.
- If no Air Detector is attached, “No Air Detector attached” will appear. The pump’s program screens will appear, followed by screens showing the lock level setting, AutoLock setting (if in use), Air Detector status (if an Air Detector is attached), time, and date. You may need to confirm certain settings before power up will continue. If messages appear, see the Alarms and Messages Table in Section 6 of this manual for further explanation and instruction.
- The pump will briefly pause. Then a message will appear showing that the PCA delivery mode is currently active.
- When power up is complete, “Power Up Successful” will appear, six beeps will sound, and the pump will be stopped.

NOTE:

- When the pump is powered up in Lock Level 0 with an Air Detector attached, the pump will automatically turn on the Air Detector (the Air Detector setting in Options will change to “Turned On.”)
- To move quickly through the power up screens, press  repeatedly. To skip the automatic review entirely, press .

Changing to Lock Level 0 (LL0)

Before programming the pump, make sure the lock level is LL0. LL0 allows the clinician to access all programming and operating functions.

To change the lock level

1. Make sure the pump is stopped.
Press **LOCK**. The current lock level will appear. (If the lock level is already LL0, press **NEXT** to exit.)

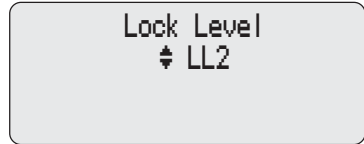

2. Press **▲** or **▼** until "LL0" appears.



3. Press **LOCK** again. "000" will appear.



NOTE: If <Custom> appears on the screen, the Lock Level Code has been customized. Enter the custom Lock Level Code in the next step.

4. Press **▲** or **▼** until
**** Text Omitted ****



WARNING: Do not disclose to the patient the pump's security codes or any other information that would allow the patient complete access to all programming and operating functions. Improper programming of the pump could result in death or serious injury to the patient.

5. Press **LOCK** to set the new lock level. Watch the display to verify that the correct lock level is being entered. If you do not see this message, the lock level has not changed. Repeat the above steps.

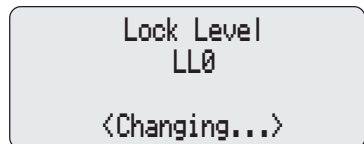

NOTE: To check the lock level, press **LOCK**. The current lock level will appear. To return to the screen you were on, press **NEXT**.

Programming the Pump: General Instructions

The procedure for changing a programmed setting is similar for most programming screens. The following example of the Reservoir Volume screen illustrates the typical features of a programming screen:

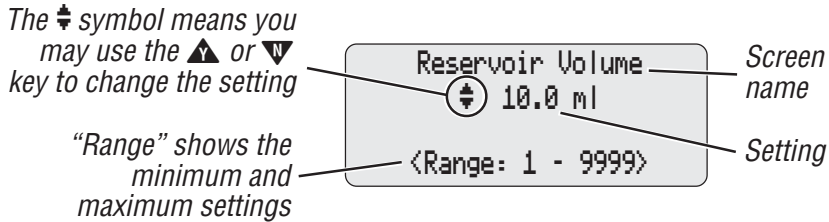

- Make sure the pump is stopped and in Lock Level 0.
- To begin programming, start at the main screen and press **ENTER**.
- To change a setting, press \blacktriangleup or \blacktriangledown until the desired setting appears. (Press and hold these keys to change values with increasing speed.) Then press **ENTER** to save the new setting. The next screen will appear automatically.
- To leave a setting unchanged, press **ENTER** to go to the next screen.

Messages you may see during programming

During programming, the following messages may appear:

“Press **ENTER** to save” will appear 10 seconds after you change a setting to remind you to press **ENTER**.

“Entering...” “Changing...” or “Resetting...” means the new setting is being entered into the pump’s memory. The pump will display this message, then automatically go to the next screen.

“Change — to...?” may appear for the following reasons:

- you entered a new setting that must be confirmed,
- entry is required because you changed Units or Concentration, or
- you changed a setting and pressed a key other than **ENTER**.

Press \blacktriangleup to confirm the setting. If you do not press \blacktriangleup within 20 seconds, or if you press \blacktriangledown , the screen will revert to the previous setting. PCA Delivery Method

PCA Delivery Method

The PCA delivery mode provides the following methods of delivery:

- **Continuous Rate**
- **Demand Dose**, activated by the patient
- **Clinician Bolus**, a dose activated by the clinician.

You may program each of the methods individually or in combination with each other. The Continuous Rate and Demand Dose are programmed as described in this section. The Clinician Bolus feature is described in Section 3, Operating the Pump. Ranges and programming increments are listed in the Specifications in Section 6.

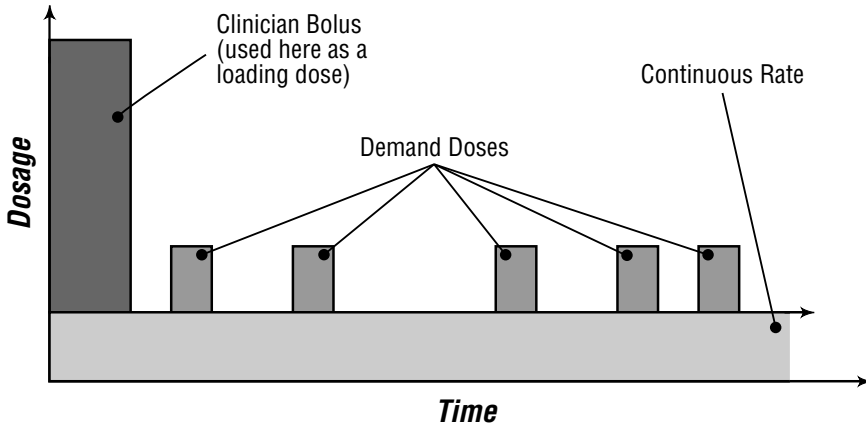

Programming Screens for PCA Delivery

The following figure illustrates the programming screens that are available in the PCA delivery mode:

Reservoir Volume	Reservoir Volume ⬆ 100.0 ml <Range: 1 - 9999>
Units	Units ⬆ Milligrams <Range: mg or ml>
Concentration (ml, mg or mcg)	Concentration ⬆ 1.0 mg/ml <Range: 0.1 - 100>
Continuous Rate	Continuous Rate ⬆ 5.00 mg/hr <Range: 0 - 30.00>
Demand Dose	Demand Dose ⬆ 2.50 mg <Range: 0 - 9.90>
Demand Dose Lockout Time	Demand Dose Lockout ⬆ 15 Min <Range: 5 min-24 hr>
Max Doses per Hour	Max Doses Per Hour ⬆ 2 <Range: 1 - 4>

Dose Counter

```
Dose Counters
Given/Attempt: 0/ 0
since 06/08/05 10:35
Press ENTER to clear
```

Given

```
Milligrams Given
0.00 mg
since 06/08/05 10:35
Press ENTER to clear
```

Air Detector (review)

```
Air Detector
Required

<Review Only>
```

New Patient Marker (optional)

```
To insert New Patient
Marker and clear
Extended History
press ENTER
```

Reservoir Volume

Enter the volume of fluid contained in the fluid container. The Reservoir Volume value decreases as the pump delivers fluid or you use the priming feature. When you change the fluid container and reset the Reservoir Volume, the value resets to the value entered on this screen. If you do not wish to use the Reservoir Volume feature, scroll down to “Not In Use” (located before 1 and after 9999 in the range of values).

Units

Enter the programming units. Possible settings are milliliters and milligrams. Micrograms will also be one of the choices if the Micrograms settings in the Biomed Toolbox is “On.” When you change the Units, the pump requires you to enter or verify the Continuous Rate and Demand Dose. If the units are mg or mcg, you must also enter the Concentration. Changing the Units clears the amount Given and the Extended History.

Concentration

If Units are mg or mcg, enter the concentration of drug in mg/ml or mcg/ml. When you enter a new Concentration, the pump requires you to enter a new Continuous Rate and Demand Dose.

Continuous Rate

Enter the continuous rate of medication delivery (in mg/hr, ml/hr, or mcg/hr, depending on the Units). The maximum rate is 30 ml/hr or the mg or mcg equivalent. If the prescription does not call for a Continuous Rate, enter zero.

NOTE: If you intend to run the pump in Lock Level 1 so the Continuous Rate can be varied, you should enter the maximum allowable rate while programming in Lock Level 0. After programming, you may then change to Lock Level 1 and decrease the rate to its starting value. See Programming with Upper Limits, Adjusting Doses in LL1 at the end of Section 2.

Demand Dose

Enter the amount of drug to be delivered when the patient presses the  key (or the Remote Dose Cord button if attached). If the prescription does not call for a Demand Dose, enter zero.

NOTE: If you intend to run the pump in Lock Level 1 so the Demand Dose can be varied, you should enter the maximum allowable dose while programming in Lock Level 0. After programming, you may then change to Lock Level 1 and decrease the dose to its starting value. See Programming with Upper Limits, Adjusting Doses in LL1 at the end of Section 2.

Demand Dose Lockout

If you programmed a Demand Dose, enter the minimum amount of time that must elapse between the time one Demand Dose starts and the time the next Demand Dose starts. This lockout period is unaffected by removal of the battery or stopping of the pump.

Max Doses Per Hour

This screen will appear only if the Max Doses per Hour is “On“ in the Biomed Toolbox. If you programmed a Demand Dose, enter the maximum number of Demand Doses allowed in any one-hour period. The possible values may be

limited by the Demand Dose Lockout time you entered. If the Demand Dose Lockout is one hour or greater, this screen will not appear. The actual lockout time will be determined by either the Demand Dose Lockout or the Max Doses Per Hour, whichever is more restrictive. The Max Doses Per Hour limit is unaffected by removal of the battery or stopping of the pump.

NOTE: The number shown on this screen may be outside of the range; this can happen when the Demand Dose Lockout time is changed but the Max Doses Per Hour number is not adjusted. If you scroll through the numbers, only numbers within the range will appear.

Dose Counters

This screen appears if you programmed a Demand Dose. It shows the number of Demand Doses given and attempted since the date and time indicated, which is the last time they were cleared. (If the counters reach 999, they automatically return to zero and continue counting.) Even if these counters show zeroes, you should clear this screen during programming to update the time and date markers.

- **Given** shows the number of Demand Doses actually delivered to the patient, including doses stopped in progress.
- **Attempt** shows the total number of Demand Doses attempted by the patient while the pump was running, including doses that were delivered, locked out, and stopped in progress.

(Units) Given

This screen shows the total amount of drug delivered since the time and date indicated, which is the last time this value was cleared. The amount shown is rounded to the nearest 0.01 mg, ml, or mcg. (If this value reaches 99999.99, it automatically returns to 0 and continues counting. For concentrations of 0.5, 0.4, 0.3, 0.2 and 0.1 mg/ml, the value changes at 49999.99, 39999.99, 29999.99, 19999.99, and 9999.99 mg respectively.) The Given amount does not include drug delivered with the priming feature. Even if this screen shows zero, you should clear this screen during programming to update the time and date markers.

Air Detector Status

This screen appears only if an Air Detector is attached to the pump. It indicates whether the Air Detector is required, turned on, or turned off.

New Patient Marker

This screen appears only if the Extended History is “On” in the Biomed Toolbox. When you add a New Patient Marker, an event is added to the Event Log to indicate the pump was programmed for a new patient, and any previous information contained in the Extended History is cleared.

PCA Programming Example

WARNING: Ensure that the $\pm 6\%$ System Delivery Accuracy specification is taken into account when programming the pump and/or filling the Medication Cassette Reservoir. Failure to do so may result in medication in the reservoir becoming depleted sooner than expected. If the pump is being used to deliver critical or life sustaining medication, the interruption in the delivery of medication could result in patient injury or death.

Medication is provided in a 100 ml Medication Cassette Reservoir at a concentration of 1.0 mg/ml. The patient should receive medication continuously at 5.0 mg/hr. Patient-activated doses of 2.5 mg are allowed, with a 15 minute lockout time between doses, and a maximum of 2 doses per hour.

In this scenario, the pump would be programmed as follows (for a full description of each screen, see the preceding pages):

1. Begin at the main screen

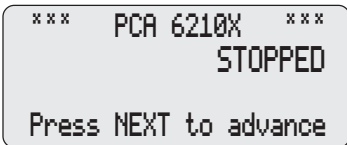

- Make sure the pump is in LL0.
- Make sure PCA and STOPPED appear on the main screen.
- Press **NEXT** to begin.

2. Enter the Reservoir Volume



- Press **▲** or **▼** to select the desired volume. (If you do not wish to use the Reservoir Volume feature, scroll down to “Not In Use” located before 1.)
- Press **ENTER**.

3. Enter the Units

To accept the current programming Units, press **NEXT**.

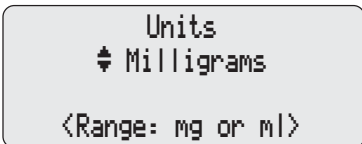

Or, to change the units:

- Press **▲** or **▼** to select the desired programming units.

```

Change Units to
  Milligrams?

Press Y or N
  
```

- Press **ENTER**.
- Press **▲** to confirm the change.

NOTE: If the prescription calls for milliliters, enter Milliliters and skip to step 5.

4. Enter the Concentration of the drug

This screen will not appear if the units are milliliters; go to step 5.

```

Concentration
  1.0 mg/ml
<Range: 0.1 - 100>
  
```

```

Change Concentration
  to 1.0 mg/ml?

Press Y or N
  
```

- Press **▲** or **▼** to select the desired concentration. (If you cannot select the desired concentration, it may have been turned off in the Biomed Toolbox)
- Press **ENTER**.
- Press **▲** to confirm the change.

NOTE: If you change the Concentration, you *must* enter the Continuous Rate and Demand Dose.

5. Enter the hourly Continuous Rate

```

Continuous Rate
  5.00 mg/hr
<Range: 0 - 30.00>
  
```

- Press **▲** or **▼** to select the desired rate.
- Press **ENTER**.

NOTE: If “Change Rate to...?” appears, you must confirm the rate because the Units or Concentration was changed, or the rate is greater than or equal to 100 mg/hr or mcg/hr. Press **▲** to confirm, or press **▼** and re-enter the rate.

6. Enter the Demand Dose amount

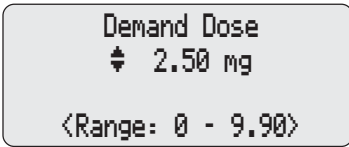

- Press ▲ or ▼ to select the desired amount.
- Press **ENTER**.

NOTE: If “Change Demand Dose to...?” appears, you must confirm the dose because the Units or Concentration was changed, or the dose is greater than or equal to 100 mg or mcg. Press ▲ to confirm, or press ▼ and re-enter the dose.

7. Enter the Demand Dose Lockout time

If Demand Dose is zero, this screen will not appear; go to step 10.

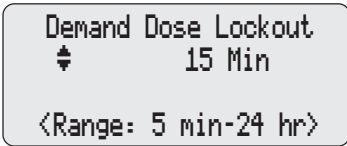

- Press ▲ or ▼ to select the desired lockout time between doses.
- Press **ENTER**.

WARNING: When you enter a new Demand Dose Lockout time, any lockout time in effect will be cleared. A Demand Dose could be requested and delivered immediately upon starting the pump, resulting in over-delivery, which could result in death or serious injury to the patient.

8. Enter the Max Doses Per Hour

This screen will appear only if the Max Doses Per Hour function is on. If Demand Dose is zero or the Lockout is one hour or greater, this screen will not appear; go to step 10.

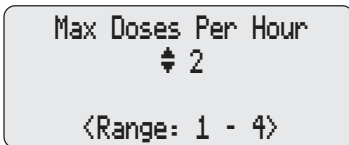

NOTE: The number shown on this screen may be outside of the range; this can happen when the Demand Dose Lockout time is changed but the Max Doses Per Hour number is not adjusted. If you scroll through the numbers, only numbers within the range will appear.

- Press ▲ or ▼ to select the maximum number of doses per hour.
- Press **ENTER**.

WARNING: When you enter a new Max Doses per Hour value, any lockout time in effect will be cleared. A Demand Dose could be requested and delivered immediately upon starting the pump, resulting in over-delivery, which could result in death or serious injury to the patient.

9. Clear the Dose Counters

If Demand Dose is zero, this screen will not appear; go to step 10.

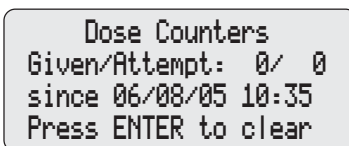

- Press **ENTER** if you wish to clear the counters; even if the counters are zero, this updates the time and date markers.

10. Clear the units Given

```

Milligrams Given
  0.00 mg
since 06/08/05 10:35
Press ENTER to clear
    
```

- Press **ENTER** if you wish to clear the amount given; even if the amount is zero, this updates the time and date markers.

11. Verify the Air Detector status

This screen will appear only if an Air Detector is installed.

```

Air Detector
Required

<Review Only>
    
```

- Make sure the setting is correct.

NOTE: If the Air Detector is not required, this screen will show whether it is turned on or off.
- Press **NEXT** to continue. If you need to correct the Air Detector setting, see Section 4, Options.

12. Enter a New Patient Marker (optional)

This screen will appear only if the Extended History is on.

If you do not wish to add a New Patient Marker, press **NEXT**.

```

To insert New Patient
Marker and clear
Extended History
press ENTER
    
```

```

Clear Extended
History and insert
New Patient Marker?
Press Y or N
    
```

If you wish to add a New Patient Marker to the Event Log,

- Press **ENTER**.
- Press **▲**. This will clear the Extended History from the last patient and add a marker to the Event Log. The main screen will reappear.

13. Review the program

Press **NEXT** repeatedly to review the programming screens. If you need to reprogram a setting, press **NEXT** until the appropriate screen appears and change the setting as described in this section.

Removing a Cassette

WARNING: Always close the fluid path tubing with the clamp before removing the cassette from the pump to prevent unregulated gravity infusion, which could result in death or serious injury to the patient.

1. Close the tubing clamp.
2. Insert the key and turn the lock clockwise one-quarter turn until it stops.

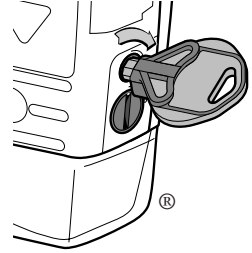

3. Use a coin or the side of the key to unlatch the cassette. Insert the coin or side of the key into the slot and turn clockwise until the latching button pops out.

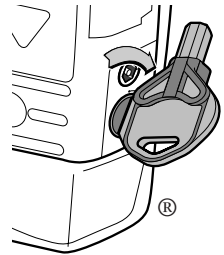

4. Remove the cassette hooks from the pump hinge pins.

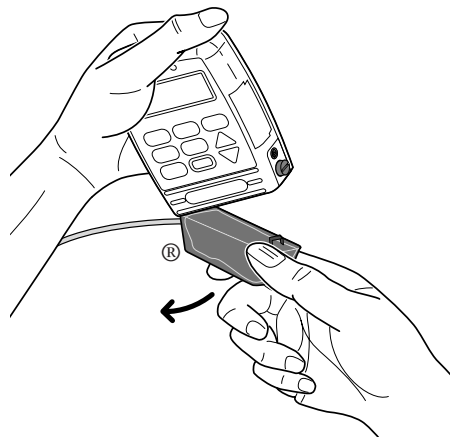

Attaching a Cassette

Obtain a new, filled Medication Cassette Reservoir, or a CADD™ Administration Set attached to a nonvented, flexible IV bag. Refer to the instructions for use supplied with the product for information on preparing the product for use.

Before you attach a new cassette, make sure a battery is installed in the pump. If a battery is installed, the pump will automatically display screens which allow you to verify the type of cassette (on the Model 6101, the screen also indicates whether the upstream occlusion sensor is on or off), reset the Reservoir Volume, prime the fluid path (depending on the lock level), change the lock level (if AutoLock is not in use and the lock level is LL0), and/or start the pump.

NOTE: You can access this sequence of screens even when you are not attaching a cassette. With the pump stopped and the main screen displayed, press **ENTER** to display the sequence beginning with verifying the type of cassette.

CAUTION: If you are using a Medication Cassette Reservoir in which the medication is frozen, thaw at room temperature only. *Do not heat in a microwave oven* as this may damage the product and cause leakage.

To attach the cassette to the pump

1. Clamp the tubing. Insert the cassette hooks into the hinge pins on the pump.
2. Place the pump upright on a firm, flat surface. Press down so the cassette fits tightly against the pump.

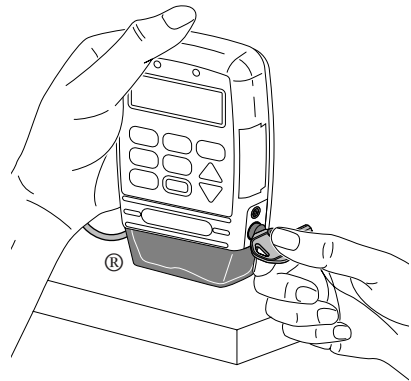

3. Insert a coin or the side of the key into the latch button, push in, and turn counterclockwise until the mark on the latch lines up with the solid dot and you feel the button click into place. A message will appear on the display so you can verify the type of cassette you have attached.

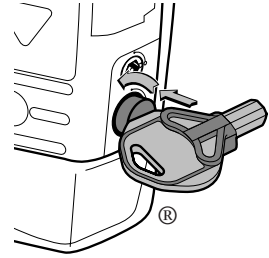

4. Insert the pump key into the lock and turn counterclockwise until the white mark lines up with the solid dot.

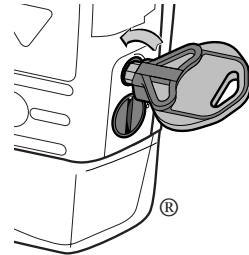

NOTE: The cassette **must be locked** in order to start the pump.

WARNING: Attach the cassette properly. A detached or improperly attached cassette could result in unregulated gravity infusion of medication from the fluid container or a reflux of blood, which could result in death or serious injury to the patient.

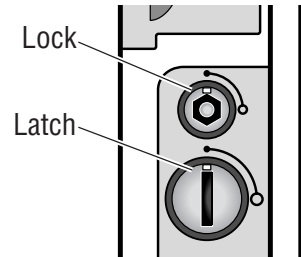

If you are using a Deltec administration set or medication cassette reservoir that does not have the flow stop feature (reorder number does not start with 21-73xx): you must use a CADD™ Extension Set with anti-siphon valve or a CADD™ Administration Set with either an integral or add-on anti-siphon valve to protect against unregulated gravity infusion that can result from an improperly attached cassette. Unregulated gravity infusion can result in death or serious injury.

-
5. Gently twist and pull on the cassette to make sure it is firmly attached.

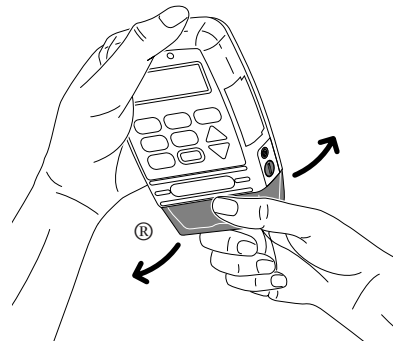



6. The message “Cassette Locked” will appear on the display. Press .



Cassette Locked

NEXT to continue

7. “Reset Reservoir Volume to...?” may appear.

- To reset Reservoir Volume to the value shown, press .
- To retain the current value, press .

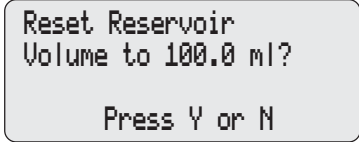

Reset Reservoir
Volume to 100.0 ml?

Press Y or N

NOTE: If this screen does not appear, Reservoir Volume is either already reset or not in use.

Priming the Tubing and Connecting to the Patient

If the lock level is LL0 or LL1 when you attach a cassette, “Prime Tubing?” will appear in the sequence of screens. Prime the tubing *before* connecting it to the patient’s infusion set or indwelling catheter.

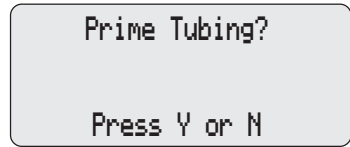

If the lock level is LL2, you cannot use the priming feature; skip to step 5 in the procedure below.

NOTE: If you are not changing the cassette but wish to prime the fluid path, you may use the Prime Option described in Section 4.

WARNING: Do not prime the fluid path with the tubing connected to a patient as this will result in over-delivery of medication, which could cause death or serious injury to the patient.

1. When “Prime Tubing?” appears, press .

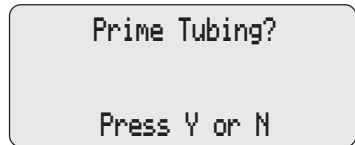

2. Make sure the tubing is disconnected from the patient and the tubing clamp is open.

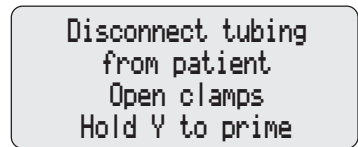

3. Press and hold the key until the tubing is fully primed or until priming stops.

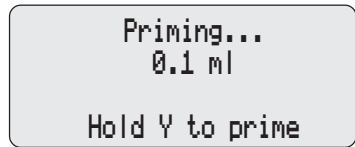

NOTE: Fluid delivered during priming is subtracted from the Reservoir Volume, but is not added to the Given screen since this fluid is not delivered to the patient.

4. If the tubing is not yet fully primed, press and repeat step 3.

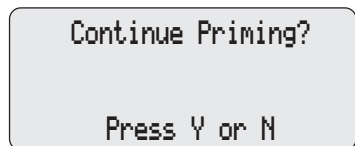

When the tubing is fully primed, press to exit priming.

5. If an Air Detector is in use, go to Inserting the Tubing into the Air Detector; if not, connect the tubing to the patient's infusion set or indwelling catheter and go to Setting the Lock Level for the Patient.

WARNING: Ensure that the entire fluid path is free of all air bubbles before connecting to the patient to prevent air embolism. Air embolism can result in death or serious injury to the patient.

NOTE: If the fluid path contains an air eliminating filter, it is acceptable for air bubbles to be present on the vent side of the filter.

Inserting the Tubing into the Air Detector

WARNING: When the Air Detector is not installed, or is installed but turned off, the pump will not detect air in the fluid path. It is recommended that you periodically inspect the fluid path and remove any air to prevent air embolism. Air embolism could cause death or serious injury to the patient.

1. If the Air Detector is in use, open the Air Detector door and thread the tubing through the groove.

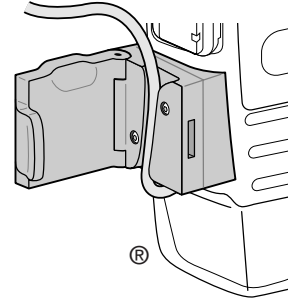

2. Close the door, making sure the tubing does not get pinched or kinked.
3. Connect to the patient's infusion set or indwelling catheter.

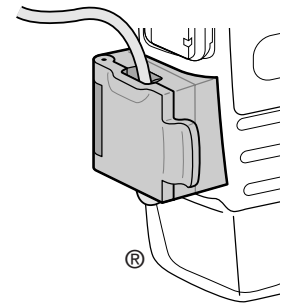

WARNING: Ensure that the entire fluid path is free of all air bubbles before connecting to the patient to prevent air embolism. Air embolism could cause death or serious injury to the patient.

NOTE: If the fluid path contains an air eliminating filter, it is acceptable for air bubbles to be present on the vent side of the filter.

8. If AutoLock is in use, or if the pump is in LL1 or LL2, “Start the Pump?” will appear; go to Starting the Pump.

If AutoLock is **not** in use and the lock level is LL0, the pump will prompt you to manually change the lock level; the screen at right will appear. Go to the next page.

AutoLock not in use.
Change Lock Level
from LL0?
Press Y or N

Setting the Lock Level for the Patient

The Lock Level must be reset to LL1 or LL2 to prevent the patient from having complete access to all programming and operating functions.

If AutoLock is not in use and the lock level is LL0 when you attach a cassette, this message will appear in the sequence of screens to allow you to set the lock level to LL1 or LL2. For detailed information on lock levels, see Lock Levels, Section 1.

AutoLock not in use.
Change Lock Level
from LL0?
Press Y or N

NOTE: You may change the lock level at any time by stopping the pump and pressing **LOCK**. Then begin with step 2 below.

To change the lock level

1. With this message displayed, press **▲**. (If you do not wish to change the lock level at this time, press **▼** and go to the next page.)

AutoLock not in use.
Change Lock Level
from LL0?
Press Y or N

2. The current lock level will appear.

Lock Level
LL0

3. Press **▲** or **▼** until the desired lock level (LL1 or LL2) appears.

Lock Level
LL1

4. Press **LOCK** again. “000” will appear.

Lock Level Code
000

NOTE: If <Custom> appears, the Lock Level Code has been customized. Use the custom Lock Level Code in the next step.

5. Press **Y** or **N** until
 ** Text Omitted **

Lock Level Code

WARNING: Do not disclose to the patient the pump's security codes or any other information that would allow the patient complete access to all programming and operating functions. Improper programming could result in death or serious injury to the patient.

6. Press **LOCK** to set the new lock level.
 Watch the display to verify that the correct lock level is being entered.

Lock Level
 LL1
 <Changing...>

Starting the Pump

1. This is the last screen to appear when you attach a cassette. If the fluid path is free of air and the set is attached to the patient, press **Y** to start the pump.
2. “Starting Pump” will appear.

Start the Pump?
 Press Y or N

The pump will review the program, lock level, AutoLock setting, time, and date. If AutoLock is in use, “AutoLock is changing lock level to (LL1 or LL2)” will appear.

Starting Pump...

After the automatic review, “RUNNING” will appear on the main screen, the green indicator light will blink, and fluid delivery will begin as programmed.

Programming with Upper Limits, Adjusting Doses in Lock Level 1

If a prescription allows for the Continuous Rate or Demand Dose to be adjusted during the course of therapy, you may wish to operate the pump in LL1. Then, when necessary, you can adjust the Continuous Rate or the Demand Dose values up to the maximum value that was programmed in LL0.

The following example shows how to set an upper Demand Dose limit of 5.00 mg with a starting value of 2.50 mg. The same procedure is used to set an upper limit and starting value on the Continuous Rate screen.

1. During initial programming in LL0, enter the **upper limit** values for the Continuous Rate and/or Demand Dose. (These will be the maximum values when the pump is in LL1.)

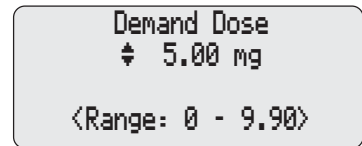

Demand Dose
⚡ 5.00 mg
<Range: 0 - 9.90>

2. After you are finished programming, change the lock level to LL1.
3. Decrease the Continuous Rate or Demand Dose to its starting value, then press **ENTER**. “Range: Limited” indicates you cannot increase the value beyond the maximum programmed in LL0.

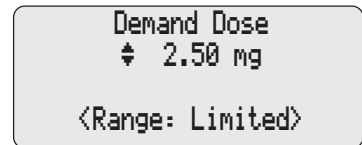

Demand Dose
⚡ 2.50 mg
<Range: Limited>

Adjusting the rate or dose while the pump is in use

If it becomes necessary to increase the Continuous Rate or Demand Dose during the course of therapy, stop the pump but *remain in LL1*.

1. Press **NEXT** until the Continuous Rate or Demand Dose screen appears.
2. Press **▲** or **▼** to select the desired value, then press **ENTER**. “Range: Limited” indicates you cannot increase the value beyond the maximum.
3. Restart the pump if appropriate.

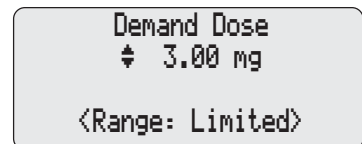

Demand Dose
⚡ 3.00 mg
<Range: Limited>

Section 3: Operating the Pump

Stopping the Pump

Stopping the pump stops delivery. “STOPPED” will appear on the main screen and the amber indicator light will blink.

To stop the pump

1. Press .

If a Demand Dose or Clinician Bolus is in progress, “Stop Demand Dose?” or “Stop Clinician Bolus?” will appear.

Press  to stop the dose.

Stop Demand Dose?

Press Y or N

2. When “Stop the Pump?” appears, press .



Stop the Pump?

Press Y or N

Starting the Pump

When you start the pump, programmed values will be automatically reviewed. Then fluid delivery will begin as programmed, RUNNING will appear on the main screen, and the green indicator light will blink. **If the pump will not start**, a message will appear on the display. Refer to the Messages and Alarms Table in Section 6.

To start the pump

1. Press . “Start the Pump?” will appear.
2. Press . “Starting Pump” will appear.

Start the Pump?

Press Y or N

The pump will review the program, lock level, AutoLock setting, Air Detector status, time, and date.

Starting pump...

If AutoLock is in use, “AutoLock is changing lock level to (LL1 or LL2)” will appear.



AutoLock is
changing Lock Level
to LL2

Starting a Clinician Bolus

A Clinician Bolus may be delivered in any lock level while the pump is running. It allows you to deliver a specified amount of drug, as a loading dose for example. Lockout settings have no affect on Clinician Bolus frequency. However, a Clinician Bolus cannot be started while a Demand Dose is in progress. The amount delivered decreases the Reservoir Volume and increases the Given amount, but does not add to the Dose Counters. A Clinician Bolus may be stopped in progress.

WARNING: Exercise extreme care when using the Clinician Bolus function. Since there are no limits on the frequency of delivering a bolus, and since the amount of the bolus can be set as high as 20 ml (or the mg or mcg equivalent), you should not permit the patient to become familiar with the procedure for giving a Clinician Bolus. Improper programming of the pump could result in death or serious injury to the patient.



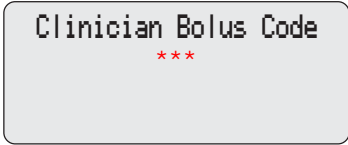

To start a Clinician Bolus

1. Make sure the pump is running (in any lock level). Start the pump if necessary.
2. Press .
3. Press  until
** Text Omitted **
4. Press  again.



Clinician Bolus Code

WARNING: To prevent the patient from accessing the Clinician Bolus function, do not let the patient know this code. Improper programming could result in death or serious injury to the patient.

5. Press  or  to select the desired amount.
6. Press  or .

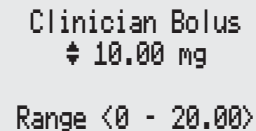

Clinician Bolus
10.00 mg
Range <0 - 20.00>

NOTE: If you enter a value of 100, a

screen will appear asking you to confirm the value. Press **▲** to confirm, or **▼** to re-enter the value.

7. The screen will show the amount decreasing as the bolus is delivered.

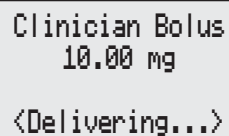

Clinician Bolus
10.00 mg
<Delivering...>

Starting a Demand Dose

If a Demand Dose has been programmed, the patient may start a Demand Dose while the pump is running. The amount delivered is added to the amount provided by the Continuous Rate. Each time the patient requests a Demand Dose, the pump will automatically add it to the Dose Counters screen. If no Demand Dose has been programmed, the pump will display the message “Dose not delivered, No Dose programmed.”

If the patient attempts to deliver a Demand Dose during the lockout time, “Dose Not Delivered, Dose Locked Out” will appear on the display and the pump will not deliver the dose. The lockout time is determined by the Demand Dose Lockout time or the Max Doses Per Hour, *whichever limits dose frequency more*. The attempt will be added to the “Attempts” counter on the Dose Counters screen.

NOTES:

- A Demand Dose cannot be started while another Demand Dose or a Clinician Bolus is in progress.
- Even if the display has automatically blanked, pressing the  key will turn the display back on and deliver a Demand Dose (if available).

To start a Demand Dose

1. Make sure the pump is running (in any lock level). Start the pump if necessary.
2. Press  (or the button on the Remote Dose Cord, if attached). Two beeps will sound and the pump will begin delivering the Demand Dose.

As the Demand Dose is delivered, the main screen will show “DOSING” in place of “RUNNING.”

```
Demand Dose
Started
NEXT to continue
```

```
*** PCA 6210X ***
Low Battery   DOSING
Res Vol      47.0 ml
Press NEXT to advance
```

Stopping a Demand Dose or Clinician Bolus

A Demand Dose or Clinician Bolus can be stopped in progress. The pump may be in any lock level. A Demand Dose that has been stopped will remain recorded on the Dose Counter screen under “Given/Attempt.”

To stop a dose while the pump is running

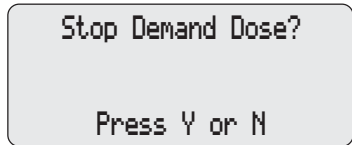

1. Press .

One beep will sound and the message “Stop Demand Dose?” or “Stop Clinician Bolus?” will appear.

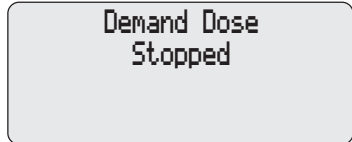

2. Press  to stop the dose and to cancel the remainder of the dose. “Demand Dose Stopped” or “Clinician Bolus Stopped” will appear.



3. When “Stop the Pump?” appears,
 - press  to remain running, or
 - press  to stop the pump.

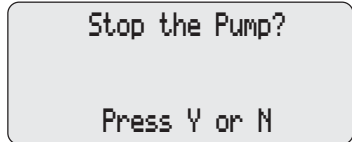

Resetting the Reservoir Volume

Resetting Reservoir Volume without changing the cassette

Normally, when you lock a cassette onto the pump as described in Section 2, a series of messages lead you through resetting the Reservoir Volume, priming the tubing, (except in LL2), and starting the pump.

You can, however, reset the Reservoir Volume without changing the cassette using the Reservoir Volume programming screen. The pump may be in any lock level.

1. Stop the pump.
2. Press **NEXT** to display the Reservoir Volume screen.
3. Press **ENTER**.
4. When this message appears, press **▲** to reset the Reservoir Volume. (If this message does not appear, the Reservoir Volume is either already reset or is not in use.)

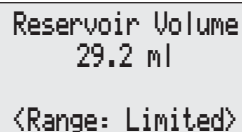

```
Reservoir Volume
  29.2 ml
<Range: Limited>
```

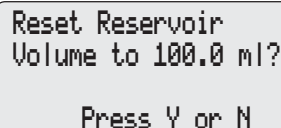

```
Reset Reservoir
Volume to 100.0 ml?
Press Y or N
```

Section 4: Options

Overview: Accessing Options

The Options menu allows access to other pump features and settings. The availability of an Option may depend on the pump's lock level, Biomed Toolbox settings, the presence of an Air Detector, and whether the pump is running or stopped. (For more information about the Communications option, refer to the product literature supplied with the CADD-Diplomat® Communications System.)

NOTE: The Delivery Modes option is not used in the PCS pump; it is designed for CADD-Prizm® pumps that contain multiple delivery modes.

To access Options

1. Start at any screen and press **OPTIONS**.
2. Use **▲**, **▼** or **OPTIONS** to page through the Options. To select an Option, make sure it is displayed on the Options Menu and press **ENTER**.
3. To exit the Options Menu, press **NEXT** until you return to the main screen.

The **⬆** symbol means you may use the **▲** or **▼** key to see more Options.

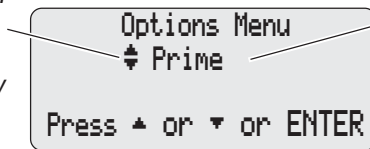

Options appear here. In this example, the "Prime" option is shown. To select the option shown, press **ENTER**. To see other options, press **▲**, **▼** or **OPTIONS**.

Prime

The Prime Option is used to pump fluid through the fluid path to remove air bubbles prior to connecting to the patient. The pump must be stopped and in Lock Level 0 or Lock Level 1 to prime.

If a cassette is attached, fluid delivered with the priming feature is subtracted from the Reservoir Volume value, but is not added to the amount Given (since this fluid is not delivered to the patient). Priming is not allowed when the Reservoir Volume value is 0.0 ml.

WARNING: Do not prime the fluid path with the tubing connected to a patient as this will result in over-delivery of medication or air embolism, which could cause death or serious injury to the patient.

1. Make sure the pump is stopped and in LL0 or LL1.

2. Press **OPTIONS**.

If necessary, press **Y** or **N** until “Prime” appears. Then press **ENTER**.

3. Make sure the tubing is disconnected from the patient and the clamp is open.

4. Press and hold the **Y** key to prime. If a cassette is attached, the volume primed will appear on the screen. When finished, release the **Y** key.

5. If the tubing is not yet fully primed, repeat step 4.

When the tubing is fully primed, press **N** to exit priming.

```
Options Menu
↓ Prime
Press ▲ or ▼ or ENTER
```

```
Disconnect tubing from
patient
Open clamps
Hold Y to prime
```

```
Priming...
0.1 ml
Hold Y to prime
```

```
Continue Priming?
Press Y or N
```

NOTE: If a cassette is not attached when the Prime feature is used, the Reservoir Volume will not be affected by the amount primed.

Options

Extended History, Viewing

The Extended History allows you to view dose information for the patient, including doses given and attempted, and the amount delivered. The pump may be running or stopped and in any lock level. You may select from two types of views:

- **Patient Review** gives a summary of the pump’s current settings and the number of doses given and attempted starting at a date and time you specify.
- **Doses Hour by Hour** allows you to page back through summaries for each one hour period, showing the number of doses given and attempted.

Both views show dose information for the past 48 hours, unless a New Patient Marker has been added, or the Units, Time, or Date have been changed. Dose information previous to any of these events will show zeroes.

NOTE: If the Extended History option does not appear, it has been turned off in the Biomed Toolbox.

To view the Extended History

These steps describe how to view the Extended History. You can also print the Extended History.

1. Press **OPTIONS**.
2. Press **▲** or **▼** until “Extended History” appears, then press **ENTER**.
3. Press **▲** or **▼** to select “Patient Review” or “Doses Hour by Hour,” then press **ENTER**.

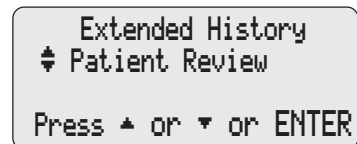
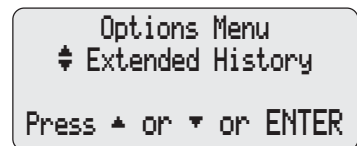

Follow the instructions for the appropriate screen on the next page.

Patient Review

1. Press **▲** or **▼** to select the start time and date. All start times begin on the hour.

```
Review Start Time
⚡ 10:00 06/07/05
Press ▲ or ▼ or ENTER
```

Press **ENTER**.

2. The first screen, “**Pump Settings 1**” will appear. Press **▲** to page forward through the Patient Review screens. Press **▼** to page backward.

```
Patient Review
⚡ Pump Settings 1
Res Vol      60.0 ml
```

NOTE: Paging past the last screen will return you to the first screen.

3. When finished, press **NEXT** to return to the Extended History screen.

NOTE: An “**x**” next to the name of a value indicates that the value applies only to the selected time period; it may not match the corresponding value in the programming screen. For example, ***Given** only reflects doses given during the selected time period, and may not match the “**Given**” value on the Dose Counters screen.

Doses Hour by Hour

1. After you select Doses Hour by Hour, the number of doses given and attempted during the *current hour* will appear.

```
Doses Hour by Hour
⚡10:00-10:59 06/08/05
*Given          1
*Attempted     2
```

- Press **▼** to page back through hours.
- Press **▲** to page forward.

NOTE: Paging past the last entry will return you to the first entry.

2. When finished, press **NEXT** to return to the Extended History screen.

AutoLock

The **AutoLock** Option automatically changes the lock level from LL0 to LL1 or LL2 when the pump is started, instead of requiring you to manually change the lock level before giving the pump to the patient. AutoLock may be set to LL1, LL2, or Not In Use.

AutoLock takes effect when you start the pump in LL0 only. It *will not* change the lock level if you set the lock level to LL1 or LL2 manually and then start the pump. This means you can set the lock level to LL1 or LL2 before you start the pump and AutoLock will not override your setting.

IMPORTANT: Changing the AutoLock setting is not the same as changing the lock level. The AutoLock setting specifies the lock level that will be set when the pump is started in LL0. To manually change the pump's lock level, see Section 2, Pump Setup and Programming.

To view or change the AutoLock setting

To view the setting, the pump may be in any lock level. To change the setting, the pump must be stopped and in LL0.

1. Press **OPTIONS**.

Press **▲** or **▼** until “AutoLock” appears, then press **ENTER**.

```
Options Menu
┆ AutoLock
Press ▲ or ▼ or ENTER
```

2. The *current* AutoLock setting will appear.

- To leave the setting unchanged and return to the Options menu, press **NEXT**.
- To change the setting, press **▲** or **▼** to select the desired lock level. (To turn off AutoLock, set it to “Not In Use.”) Then press **ENTER**.

```
AutoLock
┆ LL1
Press ▲ or ▼ or ENTER
```

Time

The **Time** Option shows the time of day in 24-hour (military) time according to the pump's internal clock. The clock is powered by a separate, internal battery which retains the time even when the 9 volt battery is removed. The time is used to record the time of events in the Event Log.

WARNING: If Demand Doses are currently locked out, changing the Time will cancel the lockout period. This will allow a Demand Dose to be requested and delivered as soon as you restart the pump, resulting in over-delivery, which could result in death or serious injury to the patient.

NOTE: Changing the time will clear the Extended History.

To change the Time of Day

To view the setting, the pump may be in any lock level. To change the setting, the pump must be stopped and in LL0.

1. Press **OPTIONS**.

Press **▲** or **▼** until "Time" appears with the time setting.

```
Options Menu
  ⚡ Time    14:45
Press ▲ or ▼ or ENTER
```

2. To change the setting, press **ENTER**.

A message will appear notifying you of other settings that will be affected by changing the time. This message will clear in a few seconds.

```
Changing time will
clear Extended
History and reset
dose lockout time
```

3. Press **▲** or **▼** to select the desired time in **24-hour military time**, then press **ENTER**.

```
Time of Day
  ⚡ 15:45
Press ▲ or ▼ or ENTER
```

4. Press **▲** to confirm the change.

```
Change Time to
  15:45?
Press Y or N
```

Date

The Date Option should reflect the current date. This feature is used to record the date of events in the Event Log.

WARNING: If Demand Doses are currently locked out, changing the Date will cancel the lockout period. This will allow a Demand Dose to be requested and delivered as soon as you restart the pump, resulting in over-delivery, which could result in death or serious injury to the patient.

NOTE: Changing the date will clear the Extended History.

To change the Date

To view the setting, the pump may be in any lock level. To change the setting, the pump must be stopped and in LL0.

1. Press **OPTIONS**.

Press **▲** or **▼** until “Date” appears with the date setting.

```
Options Menu
  † Date  02/20/05
Press ▲ or ▼ or ENTER
```

2. To change the setting, press **ENTER**.

A message will appear to notify you of other settings that will be affected by changing the date. This message will clear in a few seconds.

```
Changing date will
clear Extended
History and reset
dose lockout time
```

3. Press **▲** or **▼** to select the date, then press **ENTER**.

```
Date
  † 05/23/05
Press ▲ or ▼ or ENTER
```

4. Press **▲** to confirm the change.

```
Change Date to
  05/23/05?
Press Y or N
```

Air Detector On/Off

The **Air Detector** Option controls whether the Air Detector is turned on or off. This option appears in the menu only if an Air Detector is installed on the pump and is not required. (A setting in the Biomed Toolbox controls whether an Air Detector is required. If the Air Detector is required, you are not allowed to turn it off and this option will not appear in the menu.) The Air Detector Option can be set to “Turned On” or “Turned Off.” If the Air Detector is turned on, an alarm will sound when air is detected in the fluid path. (See Section 6 for Air Detector specifications.)

When the Air Detector is first attached to the pump, the Air Detector screen defaults to “Turned On.” This screen also changes to “Turned On” each time the pump powers up in Lock Level 0.

For certain therapies, it may be desirable to turn off the Air Detector (for example, for epidural infusion or subcutaneous infusion).

WARNING: When the Air Detector is installed but turned off, the pump will not detect air in the fluid path. It is recommended that you periodically inspect the fluid path and remove any air to prevent air embolism. Air embolism could cause death or serious injury to the patient.

To change the Air Detector setting

To view the setting, the pump may be in any lock level. To change the setting, the pump must be stopped and in LL0.

1. Press **OPTIONS**.

Press **Y** or **N** until “Air Detector” appears, then press **ENTER**.

```
Options Menu
  ⚡ Air Detector
Press ▲ or ▼ or ENTER
```

2. The current setting will appear. To change the setting, press **Y** or **N** to select the desired setting, then press **ENTER**.

```
Air Detector
  ⚡ Turned On
Press ▲ or ▼ or ENTER
```

3. Press **Y** to confirm the change.

```
Change Air Detector
to Turned On?

Press Y or N
```

Event Log, Viewing

The **Event Log** records the following types of events: dose delivery, alarms, errors, power source changes, cassette changes, changes to pump programming or settings. The pump records the date and time of each event, and lists events in order starting from the most recent through the last 500 events.

The pump may be running or stopped and in any lock level to view the Event Log.

To view the Event Log

1. Press **OPTIONS**.
2. Press **▲** or **▼** until “Event Log” appears, then press **ENTER**.
3. To view the events:
 - Press **▲** to page forward through events.
 - Press **▼** to page backward through events.

```
Options Menu
  ⚡ Event Log
Press ▲ or ▼ or ENTER
```

```
Event Log Entry
  ⚡ 06/01/05 at 10:35
  9 volt battery
  removed
```

NOTE: Paging past the last event will return you to the first event.

4. When finished, press **NEXT** to return to the Options Menu.

Section 5: Biomed Toolbox

Overview: Accessing the Biomed Toolbox

The Biomed Toolbox contains pump configurations that are less frequently changed. The Biomed Toolbox is accessible only when the pump is stopped and in Lock Level 0.

To Access the Biomed Toolbox Menu

1. Press **OPTIONS**. Press **▲** or **▼** until “Biomed Toolbox” appears, then press **ENTER**.
2. Press **Y** or **N** until
**** Text Omitted ****

```
Options Menu
⚡ Biomed Toolbox
Press ▲ or ▼ or ENTER
```

```
Biomed Toolbox Code
***
```

WARNING: Do not disclose to the patient the pump’s security codes or any other information that would allow the patient complete access to all programming and operating functions. Improper programming could result in death or serious injury to the patient.

3. Press **▲** or **▼** to select the setting you wish to view or change, then **ENTER**. Follow the instructions in this section for the appropriate screen.

```
Biomed Toolbox Menu
⚡ Micrograms [ ]
Press ▲ or ▼ or ENTER
```

NOTE: To leave a Biomed Toolbox setting unchanged, press **NEXT**.

Micrograms On/Off

This screen allows you to turn on or turn off micrograms. If micrograms are off, only milliliters and milligrams will be available for programming in the Units screen.

NOTE: If the Units programming screen is set to micrograms, you cannot turn them off. You will first need to change the Units screen to milligrams or milliliters, then return to this screen to turn off micrograms.

1. At the Biomed Toolbox Menu, press **▲** or **▼** until “Micrograms” appears. If an X appears in the box (■), Micrograms are currently on.
2. To change the setting, press **ENTER**. Press **▲** or **▼** to select the desired setting, then press **ENTER**.

```
Biomed Toolbox Menu
  ▲ Micrograms   ■
Press ▲ or ▼ or ENTER
```

```
Micrograms
  ▲ On
Press ▲ or ▼ or ENTER
```

Custom Concentrations

This screen allows you to select the concentrations that will be available for programming in the Concentration screen (mg/ml or mcg/ml). You may turn on or turn off all concentrations, except the currently programmed concentration. Then you can selectively turn on or turn off individual concentrations. For example, if only three concentrations will be used, you can turn off all concentrations, then turn on those three concentrations. **At least one concentration must be on.**

Since you cannot turn off the currently programmed concentration, you may want to change the Units programming screen to milliliters before customizing concentrations.

NOTE: Even if Micrograms have been turned off (see **Micrograms On/Off** above), you can customize Microgram concentrations.

1. At the Biomed Toolbox Menu, press **▲** or **▼** until “Custom Conc” appears. If an X appears in the box, concentrations for either mg or mcg are currently customized.

```
Biomed Toolbox Menu
  ▲ Custom Conc  ■
Press ▲ or ▼ or ENTER
```

2. To view or customize concentrations, press **ENTER**.
3. Press **▲** or **▼** to select the units (milligrams or micrograms) per ml you wish to customize, then press **ENTER**.

```

Select Units
┆ Milligrams  0
Press ▲ or ▼ or ENTER
  
```

If an X appears in the box, concentrations for these units have been customized.

4. Press **▲** or **▼** to select one of the following, then press **ENTER**.
 - **Turn On All** (this will turn on all concentrations).
 - **Turn Off All** (this will turn off all concentrations except the currently programmed concentration).
 - **Modify Individual** (this allows you to selectively turn on or turn off concentrations).

```

Select
┆ Modify Individual
Press ▲ or ▼ or ENTER
  
```

5. Turn individual concentrations on or off as appropriate:
 - Press **▲** or **▼** to select the concentration.
 - Press **ENTER** to turn the concentration on or off.
 - Repeat as necessary. When finished, press **NEXT** to return to the Biomed Toolbox screen.

```

Select Concentration
┆ 2.0 mg/ml Off
ENTER to turn on
  
```

NOTE: If you try to exit with all concentrations turned off, a message will appear reminding you that at least one concentration must be turned on.

Extended History On/Off

This screen allows you to turn the Extended History feature on or off. When turned off, Extended History will not appear in Options and the New Patient Marker screen will not appear during programming.

1. At the Biomed Toolbox Menu, press **▲** or **▼** until “Extended History” appears. If an X appears in the box, the Extended History is currently on.
2. To change the setting, press **ENTER**. Press **▲** or **▼** to select the desired setting, then press **ENTER**.

```
Biomed Toolbox Menu
┆ Extended History 0
Press ▲ or ▼ or ENTER
```

```
Extended History
┆ On
Press ▲ or ▼ or ENTER
```

Max Doses Per Hour On/Off

This screen allows you to turn on or turn off Max Doses Per Hour. If the Max Doses Per Hour function is off, doses will not be limited per hour. Doses will be limited only by Demand Dose Lockout Time. When Max Doses Per Hour is changed, any Dose Lockout Time will be cleared. The Event Log will note that the Max Doses Per Hour function was turned on or off.

1. At the Biomed Toolbox Menu, press **▲** or **▼** until “Max Dose Per Hour” appears. If an X appears in the box (X), Max Doses Per Hour function is currently on.
2. To change the setting, press **ENTER**. Press **▲** or **▼** to select the desired setting, then press **ENTER**.

```
Biomed Toolbox Menu
┆ Max Dose Per Hour X
Press ▲ or ▼ or ENTER
```

```
Max Doses Per Hour
┆ On
Press ▲ or ▼ or ENTER
```

PM (Preventive Maintenance) Reminder

If your institution or health care facility establishes a maintenance program for the pump, you can use the PM Reminder to display a “Prev. Maint. Reminder” message upon power up at a specified interval (1 to 24 months). The message will begin appearing on the date programmed and during every power up until it is reset. Use this screen to specify the interval at which the message should appear, or use it to reset the reminder.

1. At the Biomed Toolbox Menu, press **▲** or **▼** until “PM Reminder” appears. If an X appears in the box, a PM Reminder is set.

```
Biomed Toolbox Menu
  ◆ PM Reminder   □
Press ▲ or ▼ or ENTER
```

2. Press **ENTER**. The PM Reminder screen will appear.

```
PM Reminder
  ◆ 2 months
PM Due Date 07/06/05
```

- Press **ENTER** to reset the reminder, or
- Press **▲** or **▼** to select the new interval. (To turn the reminder off, select “Not In Use.”) Then press **ENTER**.

```
Next PM Reminder
  09/06/05
<Entering...>
```

3. The date corresponding to your selection (current date + number of months selected) will appear on the screen.

Custom Lock Level Code

This screen allows you to select a new Lock Level Code.

**** Text Omitted from Online Version ****

1. At the Biomed Toolbox Menu, press **▲** or **▼** until “Custom Lock” appears. If an X appears in the box, a Custom Lock Level Code is currently set.

```
Biomed Toolbox Menu
  ◆ Custom Lock   □
Press ▲ or ▼ or ENTER
```

- To view or change the Custom Lock Level Code,
**** Text Omitted ****

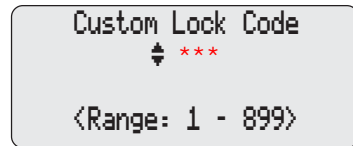

- To change the Custom Lock Level Code, press ▲ or ▼ to select the desired code (001 to 899). Then press **ENTER**.

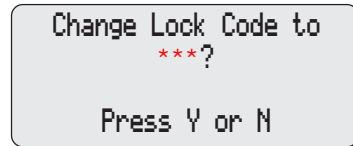

- Press ▲ to confirm the change.

Date Format

This screen allows you to select the date format. The date can be set to display in US Standard format (*month/day/year*) or in European Standard format (*day/month/year*).

- At the Biomed Toolbox Menu, press ▲ or ▼ until "Date Format" appears. Press **ENTER**.
- The current format will appear. To change the format, press ▲ or ▼. Then press **ENTER**.
- Press ▲ to confirm the change.

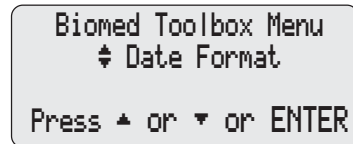

Power Source Status Display

This feature is used to select the power source display on the main screen. You may choose “Always” so the main screen will always indicate the type of power source being used, or “Only Low Battery” to display a message only when the 9 volt battery is low.

1. At the Biomed Toolbox Menu, press **▲** or **▼** until “Power Source” appears. If an X appears in the box, Power Source display is currently set to “Always.”

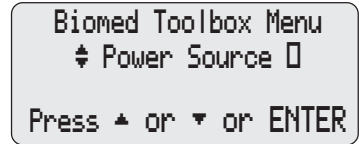

2. To change the setting, press **ENTER**. Press **▲** or **▼** to select the desired setting, then press **ENTER**.

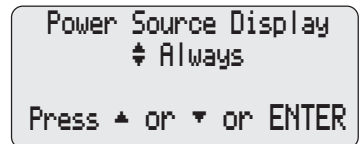

Upstream Sensor On/Off (Model 6101 only)

The Upstream Occlusion Sensor screen can be set to on or off. If this screen is set to on, and an upstream occlusion (between pump and fluid container) is detected, an alarm will sound, delivery will stop, and the display will show “Upstream Occlusion.”

WARNING: When the Upstream Occlusion Sensor is turned off, the pump will not detect occlusions upstream (between the pump and fluid container). It is recommended that you periodically inspect the fluid path for kinks, a closed clamp, or other upstream obstructions. Upstream occlusions may result in under- or nondelivery of medications. If undetected, the occlusions could lead to death or serious injury to the patient.

1. At the Biomed Toolbox Menu, press **▲** or **▼** until “Upstream Sensor” appears. If an X appears in the box, the upstream sensor is currently On.

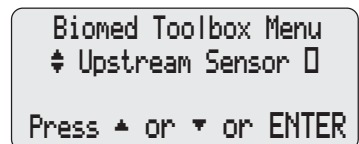

2. To change the setting, press **ENTER**. Press **▲** or **▼** to select the desired setting, then press **ENTER**.



3. Press **Y** to confirm the change.

Change Upstream
Sensor to On?

Press Y or N

Air Detector Requirement

The Air Detector screen can be set to “Required” or “Not Required.” If this screen is set to “Required,” *an Air Detector must be installed and active in order to start the pump*; however, the pump may be programmed without an Air Detector.

WARNING: When the Air Detector is not installed, or is installed but turned off, the pump will not detect air in the fluid path. It is recommended that you periodically inspect the fluid path and remove any air to prevent air embolism. Air embolism could result in death or serious injury to the patient.

1. At the Biomed Toolbox Menu, press **▲** or **▼** until “Air Detector Req” appears. If an X appears in the box, the Air Detector is currently required.
2. To change the setting, press **ENTER**. Press **Y** or **N** to select the desired setting, then press **ENTER**.
3. Press **Y** to confirm the change.

Biomed Toolbox Menu
◆ Air Detector Req □

Press ▲ or ▼ or ENTER

Air Detector
◆ Required

Press ▲ or ▼ or ENTER

Change Air Detector
to Required?

Press Y or N

Section 6: Reference & Troubleshooting

Troubleshooting

A continuous two-tone alarm is sounding; the amber light is lit or flashing.

Delivery has stopped. Read the message on the display and refer to the list of messages beginning on the next page. Press (?) to see if further information is available. If the display is blank or contains random characters, the 9 volt battery may be depleted; install a new battery. (No help is available during an error or if the battery is depleted.)

The pump is sounding 2 beeps every two seconds; the amber light is flashing.

Look at the message on the display and refer to the list of messages beginning on the next page. Or press (?) for further information.

Three beeps sound every 5 minutes.

This is a reminder that the pump is stopped.

After installing a battery, no screen appears and no beep sounds

The battery may have been installed backwards. Review the procedure for installing a battery. Be sure to match the polarity (+ and-) markings on the side of the pump with the markings on the battery. If there is still no power, the battery may be completely depleted.

Lock Level Code does not work, or I forgot the custom code

If the Lock Level Code does not work, it may have been customized.

(<Custom> will appear on the Lock Level Code screen.) If necessary, contact Smiths Medical MD's Customer Service Department for instructions on reverting to the standard Lock Level Code. If you are trying to use the custom code, it is possible that the Lock Level Code has been reset. If <Custom> does not appear on the Lock Level Code screen, try the standard code.

Printing Problems

Make sure

- the Interface Cable is connected properly to the Data In/Out jack
- printer switches are set properly (See *Instruction for Use* supplied with Interface Cable)
- the printer is plugged in and on-line
- paper is loaded with the correct side facing out, and paper is not jammed

Refer also to the printer manual supplied with the printer.

An Air In Line alarm keeps occurring even though the Air Detector was turned off

Any time you power up the pump in Lock Level 0, the Air Detector will automatically turn on. In other words, the pump will automatically change the Air Detector Option setting from "Turned Off" to "Turned On." (This does not occur in Lock Level 1 or 2.) If you do not want to use the Air Detector, you will need to change the Air Detector Option setting back to "Turned off" after the pump powers up. If the Lock Level is LL1 or LL2 when the pump powers up, the Air Detector Option setting will remain "Turned Off."

Unable to view Extended History

Extended History is turned off in the Biomed Toolbox. If appropriate, turn Extended History on (Section 5).

Unable to select Micrograms

Micrograms are turned off in the Biomed Toolbox. If appropriate, turn on Micrograms (Section 5).

Unable to add a New Patient Marker during programming

Extended History is turned off in the Biomed Toolbox. If appropriate, turn Extended History on (Section 5).

Unable to select a specific concentration

The concentration may be turned off in the Biomed Toolbox. If appropriate, turn the concentration on (Section 5). Or, the concentration may not be programmable (see scroll range tables, this section).

Alarms and Messages, Alphabetical List

Message	Corrective Action
9 volt Battery Depleted / Install good battery	Install a new 9 volt battery. The pump will not start with a depleted 9 volt battery. A good battery must always be installed even when an external source of power is connected. NOTE: This message may appear when you install a new battery while an external source of power is connected. Remove and reinstall the battery to cancel this message, then restart the pump if necessary.
9 volt Battery Low	The 9 volt battery is low but the pump is operable. Change the 9 volt battery soon. NOTE: This message may appear when you install a new battery while an external source of power is connected. Remove and reinstall the battery to cancel this message.
9 volt Battery Removed / Install good battery	The 9 volt battery has been removed with an external power source attached. Install a new 9 volt battery. Install a battery within 3 minutes to keep the pump running; after 3 minutes, the pump will stop.
9 volt Battery Removed / Pump will not run	The 9 volt battery was removed with an external power source attached. The pump is stopped. Press  to silence the alarm, then install a new battery.
AC Adapter Disconnected	The AC Adapter has been disconnected and the pump is being powered by the 9 volt battery. If desired, reconnect the AC Adapter.
AC Adapter Unpowered / Check power source	The AC Adapter is not receiving power from the wall outlet. The 9 volt battery is supplying power. Make sure the AC Adapter is properly plugged into the wall outlet and the wall outlet is supplying power. If the alarm persists, the AC Adapter may be faulty and may need to be replaced.
Air Detector Port Cover Removed / Install Cover	The cover for the Air Detector port on the side of the pump must be properly attached for the pump to operate. Remove all power. Make sure the cover is installed properly, then resume operation.

Message

Corrective Action

Air Detector Fault / Pump will not run

The Air Detector is faulty. Press **(NEXT)** to silence the alarm. Close the tubing clamp, remove the pump from use, and replace the Air Detector.

Air Detector Removed?

The Air Detector has been removed. If this is acceptable, press **▲**. If the Air Detector *should* be installed or has not actually been removed, press **▼**. Then have an Air Detector installed properly. If an Air Detector is attached and the alarm persists, have the Air Detector serviced.

Air Detector Required / Pump will not run

This message indicates that an Air Detector is required to start the pump (i.e. the Air Detector setting in the Biomed Toolbox is “Required”). If necessary, press **(NEXT)** to silence the alarm, then have an Air Detector installed.

Air in line detected / Pump will not run

The Air Detector has detected air in the fluid path; the fluid path may contain air bubbles, or the tubing may not be threaded through the Air Detector. Press **(NEXT)** to silence the alarm, then:

- Make sure the tubing is threaded properly.
- If the fluid path contains air bubbles, close the clamps and disconnect the fluid path from the patient. Then follow the instructions for removing air using the Prime Option in Section 4.

All Concentrations cannot be turned off

At least one concentration must be enabled when customizing concentrations. Press **(NEXT)**, then enable a concentration.

Cable Removed

The cable was detached from the Data In/Out jack.

Cassette Damaged / Free flow may occur / Clamp Tubing / Change Cassette

The pump detects the cassette is damaged. Close the tubing clamp and inspect the cassette for damage. Replace it if necessary.

Message	Corrective Action
Cassette Not Attached / Pump will not run	The pump will not start without a cassette attached. Make sure a cassette is attached properly. Then start the pump.
Cassette Unlocked	The current delivery mode requires the cassette to be locked onto the pump before it can be started. If an alarm is sounding, press ◻NEXT to silence the alarm. Lock the cassette, then start the pump.
Cassette Unlatched / Close clamp to prevent free flow	This message appears as a reminder to close the tubing clamp when the cassette is unlatched from the pump.
Change (setting) to (X)?	<p>The message is asking for confirmation of the value you entered. Check the value. If it is correct, press ▲Y. If it is incorrect, press ▼ and choose the correct value.</p> <p>If this message appears when you try to use ◻NEXT to go to the next screen, you may have changed the Units or Concentrations. The pump is requiring you to verify the current setting on this screen or to program a new setting.</p>
Check for empty tubing or reservoir	The tubing beneath the pump may not contain fluid, or the fluid container may be empty. Check whether the fluid container is empty; or clamp the tubing, remove the cassette, and check for air in the tubing. If the alarm persists after trying to correct the problem, remove the pump from service and contact Customer Service.
Clinician Bolus not available during Demand Dose	A Clinician Bolus may not be started while a Demand Dose is being delivered. Wait until the Demand Dose finishes, then start the Clinician Bolus if appropriate.
Clock Battery needs service soon	The clock battery must be replaced soon. When feasible, remove the pump from use and return it for replacement of the clock battery.

Message	Corrective Action
Clock Battery is low / Service immediately	The clock battery is low and must be serviced. Close the tubing clamp and remove the pump from use. Contact Customer Service for replacement of the clock battery.
Current Concentration cannot be turned off	The currently programmed Concentration cannot be disabled. Exit the Biomed Toolbox and change to a different Concentration. Then return to the Biomed Toolbox and turn off this concentration.
Delivery Too Slow / External power source must be connected	The 9 volt battery does not provide sufficient power to support the programmed delivery rate. Connect an external source of power. Or, if appropriate, acknowledge the message and allow delivery to proceed at the lower rate by pressing NEXT .
Delivery Stopped (Model 6101 only)	Fluid is not flowing from the fluid container to the pump. Check for a kink, a closed clamp, or air bubble in the tubing between the fluid container and pump. Press STOP START to stop the pump and silence the alarm for 2 minutes, then remove the obstruction and press NEXT to restart the pump.
Dose Not Delivered / Dose not available when pump is stopped	The pump must be running in order to start a Demand Dose. First start the pump, then request a Demand Dose.
Dose Not Delivered / Dose Locked Out	The Lockout Time or Max Doses per Hour is preventing the Demand Dose from being delivered. Wait until the lockout time elapses before requesting a Demand Dose.
Dose Not Delivered / No Dose programmed	The Demand Dose amount is set to 0. Therefore, a Demand Dose cannot be delivered.
Error Detected / E (code)	A pump fault has occurred. Close the tubing clamp and remove the pump from use. Contact Customer Service to return the pump for service.

Message	Corrective Action
External Power Source Faulty / Change Power Source	The power pack or the AC Adapter is faulty. Ensure the cords and cables are properly attached. If this does not correct the problem, replace the power source.
High Pressure	The pump has detected high pressure, which may be resulting from a downstream blockage, kink in the fluid path, or a closed tubing clamp. Remove the obstruction to resume operation. Or, press  to stop the pump and silence the alarm for 2 minutes, then remove the obstruction and restart the pump.
High Volume Admin set not supported in this version of PCA / Remove admin set	The CADD-Prizm™ High Volume Administration Set cannot be used with the PCA delivery mode. You must remove the set to continue.
Insufficient External Power	The AC Adapter is not receiving power or the power pack is completely depleted. Ensure the cords and cables are properly attached. Or, begin recharging the power pack.
Key Stuck / Release key or remove power to stop pump	A key may be pressed down. Make sure there is nothing pressing on any of the keys. If the alarm persists, close the tubing clamp and remove the pump from use. Contact Customer Service to return the pump for service.
Lock cassette before starting	The cassette has been properly latched to the pump. You must now lock the cassette or the pump will not run.
Micrograms On / Cannot turn off current programming units	Micrograms cannot be turned off because they are the current programming units. First, change the Units, then turn off Micrograms.
Motor is temporarily disabled / Remove power and restart pump	The pumping mechanism temporarily stopped. Remove the external power source (if applicable). Then remove and reinsert the 9 volt battery and reconnect the external power source if desired. Restart the pump.

Message	Corrective Action
Motor service due	The pump's motor requires service. Remove the pump from use at the next cassette change and contact Customer Service to return the pump for service.
No Air Detector attached	This message appears at power up to inform you that no Air Detector is attached to the pump.
No changes allowed	The current lock level does not allow changes to the setting displayed on the screen.
No Rate or Dose Programmed / Pump will not run	The pump will not start if no rate or doses have been programmed. Follow the instructions in Section 2 for programming the pump.
Possible hardware problem / Service pump	There may be a hardware problem with the Air Detector. Have the Air Detector replaced.
Power Pack Depleted / Change Power Source	The power pack is depleted and unable to support pump operation. The 9 volt battery is supplying power. Recharge the power pack with the AC Adapter.
Power Pack Disconnected	The power pack is disconnected from the pump. Reconnect the power pack, attach an AC Adapter, or allow the pump to run on the 9 volt battery power.
Prev. Maint. Reminder (date)	Your institution may have established a maintenance program for the pump, and the pump is due for preventive maintenance. Refer to your institution's policy.
Print Failure / Check printer & cable	Printing has stopped. The paper may be out or jammed, the printer may have lost power, or the printer may be off-line. Press ◻NEXT to silence the alarm and refer to the printer manual to correct the problem. Then remove and reattach the cable and repeat printing.
Printing Stopped / Print Again?	During printing, ▼ was pressed, signalling printing to stop. To start over, press ▲ . To exit printing, press ▼ .

Message**Corrective Action****Range: Limited**

This message appears on rate, dose, or Reservoir Volume screens when the pump is in LL1. It indicates that the range of programmable values is limited by the value programmed in LL0 (i.e. you cannot increase the value beyond what was programmed in LL0).

Reservoir Volume is zero

The Reservoir Volume has reached 0.0 ml. Press **NEXT** to stop the alarm. Then install a new fluid container if appropriate.

Reservoir Volume Low

The Reservoir Volume value is low, indicating that the level of fluid in the fluid container is low. Prepare to install a new fluid container.

Reset Reservoir Volume to (X) ml?

If you wish to reset the Reservoir Volume to the originally programmed value, press **▲Y**. To leave the Reservoir Volume value unchanged, press **▼N**.

To continue, unlatch and remove the Admin set or reservoir / Then reattach

The cassette was not completely removed from the pump before it was reattached and, therefore, the pump's sensors are not able to detect the cassette type. Remove the cassette and reattach it, then verify the cassette type in the pump's display. If this alarm persists, remove the pump from use and contact Customer Service to return the pump for service.

Upstream Occlusion / Press STOP to silence (Model 6101 only)

Fluid is not flowing from the fluid container to the pump. Check for a kink, a closed clamp, or air bubble in the tubing between the fluid container and pump. Press **STOP START** to stop the pump and silence the alarm for 2 minutes, then remove the obstruction and press **NEXT** to restart the pump.

Upstream Occlusion / Press STOP to stop / Press NEXT to restart (Model 6101 only)

Fluid is not flowing from the fluid container to the pump. Check for a kink, a closed clamp, or air bubble in the tubing between the fluid container and pump. Press **STOP START** to stop the pump and silence the alarm, then remove the obstruction and press **NEXT** to restart the pump.

Message

Corrective Action

Wrong Cassette

The pump detects the cassette is damaged, attached improperly, or incompatible with the pump. Close the tubing clamp. Make sure the cassette is attached properly. Then open the clamp and restart the pump. If the alarm persists, you may need to replace the cassette.

Cleaning the Pump and Accessories

CAUTIONS:

- Do not immerse the pump in cleaning fluid or water. Do not allow solution to soak into the pump, accumulate on the keypad, or enter the battery compartment, Data In/Out jack, Power jack or Air Detector Port area. Moisture buildup inside the pump could damage the pump.
 - Do not clean the pump with acetone, other plastic solvents, or abrasive cleaners, as damage to the pump may occur.
-

Use any of the following solutions to clean the pump and accessories:

- Soap solution
 - Benzalkonium Chloride concentrate (0.13%)
 - Glutaral Concentrate, USP (2%)
 - 10 percent solution of household bleach (one part household bleach to nine parts water)
 - Alcohol, USP (93%)
 - Isopropyl Alcohol, USP (99%)
1. Dampen a soft, lint-free cloth with cleaning solution. Apply the solution to exterior surface of the pump or accessory. *Do not allow the solution to soak into the pump or accessory.*
 2. Wipe the entire surface dry with another soft, lint-free cloth. Allow the pump to dry completely before use.

Cleaning the Battery Contacts

Routinely clean the battery contacts, possibly as part of the preventative maintenance cycle, to remove buildup of foreign material on the contacts.

Use the following to clean the contacts:

- Cotton swab wetted with Isopropyl Alcohol (70% minimum)

NOTE: Do not use an alcohol formulation that contains components other than alcohol and water.

OR

- Pre-moistened alcohol swab
 1. Using a swab wetted with alcohol, rub the entire battery contact for a minimum of ten back and forth cycles (twenty total wipes over the contact).
 2. Using a clean surface of the swab, repeat the process for the second battery contact.
 3. Using a clean swab wetted with alcohol, rub each battery contact again, a minimum of four back and forth cycles (eight total wipes over the contact).
 4. Allow the contacts to dry completely before use.

Exposure to Radiation or Magnetic Resonance Imaging (MRI)

CAUTION:

- Do not expose the pump to therapeutic levels of ionizing radiation as permanent damage to the pump's electronic circuitry may occur. The best procedure to follow is to remove the pump from the patient during therapeutic radiation sessions. If the pump must remain in the vicinity during a therapy session, it should be shielded, and its ability to function properly should be confirmed following treatment.
 - Do not expose the pump directly to ultrasound, as permanent damage to the pump's electronic circuitry may occur.
 - Do not use the pump in the vicinity of magnetic resonance imaging (MRI) equipment as magnetic fields may adversely affect the operation of the pump. Remove the pump from the patient during MRI procedures and keep it a safe distance away from magnetic energy.
 - Do not use the pump near ECG equipment as the pump may interfere with the operation of the equipment. Monitor ECG equipment carefully when using this pump.
-

Continuous Rate Scroll Ranges

Units	Starting Value	Increment	Maximum
Milliliters	0.10	0.10	30.00
Milligrams & Micrograms	10% of concentration	Mg only: Values between 0.01 and 0.5: Mcg only: Values between 0.1 and 0.5: Values between 0.5 and 100: Values between 100 and 1000: Values greater than 1000:	0.01 0.1 0.1 1.0 10.0

Demand Dose, Clinician Bolus Scroll Ranges: Milliliters

Milliliters			
Demand Dose		Clinician Bolus	
increment	max.	increment	max.
0.05	9.9	0.05	20

Demand Dose, Clinician Bolus Scroll Ranges: Milligrams

Concentration mg/ml	Milligrams			
	Demand Dose increment	max.	Clinician Bolus increment	max.
0.1	0.01	0.99	0.01	2
0.2	0.02	1.98	0.02	4
0.3	0.03	2.97	0.03	6
0.4	0.04	3.96	0.04	8
0.5	0.05	4.95	0.05	10
1	0.05	9.9	0.05	20
2	0.10	19.8	0.10	40
3	0.15	29.7	0.15	60
4	0.20	39.6	0.20	80
5	0.25	49.5	0.25	100
10	0.50	99.0	0.50	200
15	0.75	148.5	0.75	300
20	1.00	198.0	1.00	400
25	1.25	247.5	1.25	500
30	1.50	297.0	1.50	600
35	1.75	346.5	1.75	700
40	2.00	396.0	2.00	800
45	2.25	445.5	2.25	900
50	2.50	495.0	2.50	1000
55	2.75	544.5	2.75	1100
60	3.00	594.0	3.00	1200
65	3.25	643.5	3.25	1300
70	3.50	693.0	3.50	1400
75	3.75	742.5	3.75	1500
80	4.00	792.0	4.00	1600
85	4.25	841.5	4.25	1700
90	4.50	891.0	4.50	1800
95	4.75	940.5	4.75	1900
100	5.00	990.0	5.00	2000

Demand Dose, Clinician Bolus Scroll Ranges: Micrograms

Concentration mcg/ml	Micrograms			
	Demand Dose increment	max.	Clinician Bolus increment	max.
1	0.05	9.9	0.05	20
2	0.10	19.8	0.10	40
3	0.15	29.7	0.15	60
4	0.20	39.6	0.20	80
5	0.25	49.5	0.25	100
10	0.50	99.0	0.50	200
15	0.75	148.5	0.75	300
20	1.00	198.0	1.00	400
25	1.25	247.5	1.25	500
30	1.50	297.0	1.50	600
35	1.75	346.5	1.75	700
40	2.00	396.0	2.00	800
45	2.25	445.5	2.25	900
50	2.50	495.0	2.50	1000
55	2.75	544.5	2.75	1100
60	3.00	594.0	3.00	1200
65	3.25	643.5	3.25	1300
70	3.50	693.0	3.50	1400
75	3.75	742.5	3.75	1500
80	4.00	792.0	4.00	1600
85	4.25	841.5	4.25	1700
90	4.50	891.0	4.50	1800
95	4.75	940.5	4.75	1900
100	5.00	990.0	5.00	2000
200	10.00	1980.0	10.00	4000
300	15.00	2970.0	15.00	6000
400	20.00	3960.0	20.00	8000
500	25.00	4950.0	25.00	10000

Military Time Conversion Chart

12-Hour Time	Military Time
12:00 AM (midnight)	00:00
1:00 AM	01:00
2:00 AM	02:00
3:00 AM	03:00
4:00 AM	04:00
5:00 AM	05:00
6:00 AM	06:00
7:00 AM	07:00
8:00 AM	08:00
9:00 AM	09:00
10:00 AM	10:00
11:00 AM	11:00
12:00 PM (noon)	12:00
1:00 PM	13:00
2:00 PM	14:00
3:00 PM	15:00
4:00 PM	16:00
5:00 PM	17:00
6:00 PM	18:00
7:00 PM	19:00
8:00 PM	20:00
9:00 PM	21:00
10:00 PM	22:00
11:00 PM	23:00

Specifications (Nominal)

PCA Delivery Mode Specifications

Reservoir Volume	1 to 9999 or Not In Use; programmable in 1 ml increments, displayed in 0.1 ml increments
Units	Milliliters (ml), milligrams (mg), micrograms (mcg)
Concentration	Mg/ml: 0.1, 0.2, 0.3, 0.4, 0.5, 1, 2, 3, 4, 5, 10, 15, ... 95, 100 Mcg/ml: 1, 2, 3, 4, 5, 10, 15, ... 95, 100, 200, 300, 400, 500
Continuous Rate	0 – 30 ml/hr (or the mg or mcg equivalent)
Demand Dose	0 to 9.9 ml Delivery rate (Continuous Rate + Demand Dose): 125 ml/hr nominal
Demand Dose Lockout	5 minutes to 24 hours in the following increments: 1 minute for values between 5 and 20 minutes 5 minutes between 20 minutes and 24 hours
Max Doses Per Hour	1 – 12 doses in 1 dose increments (will also be limited by the Demand Dose Lockout value)
Demand Doses Given	0 to 999
Demand Dose Attempts	0 to 999
Given	0 to 99999.99 in 0.01 unit increments
Clinician Bolus	0.1 ml to 20.00 ml (or mg or mcg equivalent) Delivery rate (Continuous Rate + Clinician Bolus): 125 ml/hr nominal
High Pressure Alarm	18 ± 9 psi
Air Detector Alarm	Single bubble greater than 0.100 ml

General Pump Specifications

Resolution	Medication Cassette Reservoir or CADD™ Administration Set, 0.050 ml per pump stroke nominal
Size	4.4 cm × 10.4 cm × 14.1 cm (1.7 in. × 4.1 in. × 5.6 in.) excluding cassette or other accessories

Weight	568 g (20 oz.) including 9 volt battery and empty 100 ml Medication Cassette Reservoir, excluding other accessories
Pump Alarms	Low battery power; depleted battery power; external power source low, faulty, depleted; pump stopped; pump fault; low reservoir volume; high delivery pressure; air in line; Air Detector faulty or detached (only with the use of the optional Air Detector); Air Detector Port Cover detached; delivery too slow; key stuck; cassette detached or unlocked; print failure.
Bolus Volume at Occlusion	
Alarm Pressure	0.050 ml resolution administration sets/Medication Cassette Reservoirs: <0.25 ml 0.100 ml resolution administration sets: <2.0 ml
Power Sources	9 volt alkaline or lithium battery such as DURA-CELL® Alkaline MN 1604 or ULTRALIFE® Lithium U9VL; CADD™ External Power Source (EPS) Power Pack reorder number 21-3801; AC Adapter.
	The expected life of a 9 volt battery is 12 hours at 100 ml/hour, or approximately 5 days at 10 ml/day (nominal). This estimate is based on laboratory tests conducted at room temperature using a new battery. Actual battery life will vary depending on the brand of battery, battery shelf life, temperature conditions, delivery rate, and frequency of screen display, back-lighting and printing. It is recommended that a new 9 volt battery be kept available for replacement if necessary.
	An internal battery powers the clock. When it is depleted, it cannot reliably maintain the clock time. This battery must be replaced by the manufacturer. The internal battery has an expected life of 5 years.
System Operating	
Temperature	+2°C to 40°C (36°F to 104°F)
System Storage	
Temperature	-20°C to 60°C (-4°F to 140°F)
Power Pack Charging	
Temperature	+10°C to 35°C (50°F to 95°F)
System Delivery	
Accuracy	± 6% (nominal)

WARNING: Ensure that the $\pm 6\%$ System Delivery Accuracy specification is taken into account when programming the pump and/or filling the Medication Cassette Reservoir. Failure to do so may result in medication in the reservoir becoming depleted sooner than expected. If the pump is being used to deliver critical or life sustaining medication, the interruption in the delivery of medication could result in patient injury or death.

System Definition..... System is defined as a CADD-Prizm® pump with an attached Medication Cassette Reservoir and CADD™ Extension Set with integral anti-siphon valve, or an attached CADD™ Administration Set with integral or add-on anti-siphon valve. OR a CADD-Prizm® pump with an attached Medication Cassette Reservoir with flow stop feature and CADD™ Extension Set, or a CADD™ Administration Set with flow stop feature (reorder numbers start with 21-73xx).

Options Specifications

AutoLock Not In Use, LL1, or LL2
Time 00:00 to 23:59
Air Detector Turned On or Turned Off
Event Log 0 – 500 events
Extended History Up to 48 hours in 1 hour increments

Biomed Toolbox Specifications

PM (Preventive Maintenance)
Reminder 1 to 24 months in 1 month increments, Not In Use
Custom Lock Level Code 001 – 899 (excluding preset code) in increments of 1
Date Format US Standard (mm/dd/yy) or European Standard (dd/mm/yy)
Power Source Display Always display or Only Low Battery
Air Detector Required Required or Not Required

Printing Reports

An Interface cable is available for printing or communications. Three types of reports are available: the Rx Settings Report lists the pump's current program; the Event Log Report includes Rx settings and the event log through the last 500 events or the last delivery change mode (see Section 4 for a description of the event log); the Extended History Report lists current pump settings, amount of medication delivered, and hourly dose summaries for the time period you specify (for the past 48 hours or to the last New Patient Marker or Change in Units, Time, or Date; beyond any of these events, the report will show zeroes). Extended History must be on in the Biomed Toolbox for this report to be available.

For additional information on printing or communications, see the *Instructions for Use* provided with the interface cable.

Index

Bold page numbers indicate figure references

Symbols

“?” key. *See* Help key

A

- AC Adapter, 5, 6, 69, 70, 85
- administration
 - warning, xcvi
- administration set, 6, 73
- Air Detector, 5, 15, 66, 69, 70, 74, 85, 86
 - loading tubing into, 36
 - status screen, 23, 28, 41
 - turning on/off, 56
- Air Detector Port Cover, 5
- Air Detector Requirement, 56, 66, 70, 86
- alarms, 69–78, 85
- amber indicator light, 3, 4, 41
- analgesics, 1
- anesthetics, 1
 - caution, xcix
- AutoLock, 10, 11, 15, 39, 41, 42, 86
 - setting, 53

B

- backlighting, 4
- battery, 9 volt, 3, 6, 8, 65, 69, 85, 86
 - installing, 13
 - warning, xcvi
- battery, clock, 54, 71
- battery life, 85
- Biomed Toolbox, 20, 23, 51, 59, 86
 - Air Detector Requirement, 66, 70
 - Concentration Customization, 60
 - Custom Lock Level Code, 63
 - Date Format, 64
 - Extended History on/off, 62

- micrograms on/off, 60
- Power Source Status Display, 65
- Preventive Maintenance Reminder, 63
- screen map, 59
- Upstream sensor on/off, 65
- Biomed Toolbox Code, 10, 59, 63
- blood
 - warning, xcvi

C

- cassette, 3
 - attaching, 31
 - removing, 30
 - warnings, 32, xcvi, xcvi
- cassette latch, 6, 32
- cassette lock, 6, 32
- cautions, xcvi
- Clinician Bolus, 11, 71, 80, 81, 82, 84
 - starting, 43
 - stopping, 46
- Clinician Bolus Code, 10, 43
- clock battery, 71
- codes. *See* security codes
- communications, 87
- concentration, 21, 70, 72, 84
 - programming, 25
- concentrations, customizing, 60–61
- Continuous Rate, 11, 20, 21, 40, 84
 - programming, 19, 25
- Custom Lock Level Code, 10, 63, 67, 86

D

- Data In/Out jack, 3, 5, 77
- date, 11, 55
 - warning, xcvi
- date format, 64, 86
- delivery mode, 15
- Demand Dose, 11, 18, 19, 21, 22, 25, 26, 27, 40, 54, 72, 80, 81, 82, 84
 - programming, 26
 - starting, 45
 - stopping, 46
- Demand Dose Lockout, 21, 22, 45

programming, 26
 Dose Counters, 22, 27
 clearing, 27
 Dose key, 21, 45
 Doses Hour by Hour, 51, 52
 Downstream Occlusion Sensor, 7

E

epidural, xcvi
 epidural administration, 1
 Event Log, 11, 23, 28, 57, 86
 Extended History, 23, 28, 51–52, 54, 55, 86
 Doses Hour by Hour, 51
 Patient Review, 51, 52
 turning on/off, 62
 viewing, 51

G

Given screen, 22, 28
 clearing, 28
 green indicator light, 3, 4, 39, 41

H

Help, help key, 4, 8, 9, 11
 history. *See* Extended History or Event Log

I

indicator lights, 3, 4, 39, 41
 Interface Cable, 5

K

keypad, keys, 3, 4

L

latch, cassette, 3, 6, 32
 lock, cassette, 3, 6, 32
 lock level, 4, 9, 10, 11, 15, 39, 41

changing, 16, 38
 Lock Level Code, 10, 16, 38
 customizing, 10, 63
 Lockout, Demand Dose, 21, 22, 26, 45

M

Magnetic Resonance Imaging, 79
 main screen, 8, 41, 65
 Marker, New Patient, 23, 28
 Max Doses Per Hour, 21
 programming, 27
 messages, list, 69–78
 micrograms, 20, 60, 62, 68, 73, 82, 84
 turning on/off, 60
 military time conversion table, 83
 milligrams, 81
 milliliters, 80

N

“N” (No) key, 5
 New Patient Marker, 23, 28

O

occlusion sensor, downstream. *See* downstream occlusion sensor
 occlusion sensor, upstream. *See* Upstream occlusion sensor
 Options, 11, 49–57, 84
 Air Detector On/Off, 56
 Date, 55
 Prime, 50
 screen map, 49
 Time, 54

P

Patient Review, 51, 52
 PM Reminder. *See* Preventive Maintenance Reminder

Polemount Bracket, 6
Polemount Bracket recess, 3
Power jack, 3, 5, 77
power pack, 5, 6, 74, 85
Power Source Status Display, 65
power-up, 15, 63
Preventive Maintenance Reminder
 setting/resetting, 63
Prime Option, 50
priming, 11, 20, 22, 35, 50
 warning, xcvi
printing, 5, 11, 67, 74, 75, 87
programming, 17–18
 screen map, 49, 59

R

radiation, exposure to, 79
rate. *See* Continuous Rate
Remote Dose Cord, 5, 21, 45
reports. *See also* printing
reservoir, 6, 75, 85
 warning, xcvi
Reservoir Volume, 7, 8, 11, 18, 20, 24,
 34, 47, 75, 84, 85
 resetting, 33, 47

S

scroll down key. *See* “N” (No) key
scroll up key. *See* “Y” (Yes) key

security codes
 Biomed Toolbox Code, 10, 59, 63
 Clinician Bolus Code, 10
 customizing, 10, 63
 Lock Level Code, 10, 16, 38, 63, 67
subarachnoid administration, 1
 warning, xcvi
syringe
 warning, xcv

T

time, 11, 54, 86
troubleshooting, 67–76

U

units, 20. *See also* micrograms
 programming, 24
Upstream occlusion sensor, 65, 75

W

warnings, xcv

Y

“Y” (Yes) key, 5

Limited Warranty

Smiths Medical MD, Inc. (the “Manufacturer”) warrants to the Original Purchaser that the infusion pump (the “Pump”), not including accessories, shall be free from defects in materials and workmanship under normal use, if used in accordance with this Operator’s Manual, for a period of two years from the actual date of sale to the Original Purchaser. **THERE ARE NO OTHER WARRANTIES.**

This warranty does not cover normal wear and tear and maintenance items, and specifically excludes batteries, administration sets, extension sets or any other accessory items or equipment used with the Pump.

Subject to the conditions of and upon compliance with this Limited Warranty, the Manufacturer will repair or replace at its option without charge (except for a minimal charge for postage and handling) any Pump (not including accessories) which is defective if a claim is made during such two-year period.

The following conditions, procedures, and limitations apply to the Manufacturer’s obligation under this warranty:

A. Parties Covered by this Warranty: This warranty extends only to the Original Purchaser of the Pump. This warranty does not extend to subsequent purchasers. The Original Purchaser may be a patient, medical personnel, a hospital, or institution which purchases the Pump for treatment of patients. The Original Purchaser should retain the invoice or sales receipt as proof as to the actual date of purchase.

B. Warranty Performance Procedure: Notice of the claimed defect must be made in writing or by telephone to the Manufacturer as follows: Customer Service Department, Smiths Medical MD, Inc., 1265 Grey Fox Road, St. Paul, MN 55112, (800) 426-2448. Notice to the Manufacturer must include date of purchase, model and serial number, and a description of the claimed defect in sufficient detail to allow the Manufacturer to determine and facilitate any repairs which may be necessary. **AUTHORIZATION MUST BE OBTAINED PRIOR TO RETURNING THE PUMP.** If authorized, the Pump must be properly and carefully packaged and returned to the Manufacturer, postage prepaid. Any loss or damage during shipment is at the risk of the sender.

C. Conditions of Warranty: The warranty is void if the Pump has been 1) repaired by someone other than the Manufacturer or its authorized agent; 2) altered so that its stability or reliability is affected; 3) misused; or, 4) damaged by negligence or accident. Misuse includes, but is not limited to, use not in compliance with the Operator’s Manual or use with nonapproved accessories. The Pump is a sealed unit, and the fact that the seal has been broken will be considered conclusive evidence that the Pump has been altered or misused. Removal or damage to the Pump’s serial number will invalidate this warranty.

D. Limitations and Exclusions: Repair or replacement of the Pump or any component part thereof is the **EXCLUSIVE** remedy offered by the Manufacturer. The following exclusions and limitations shall apply:

1. No agent, representative, or employee of the Manufacturer has authority to bind the Manufacturer to any representation or warranty, expressed or implied.

2. **THERE IS NO WARRANTY OF MERCHANTABILITY OR FITNESS OR USE OF THE PUMP FOR ANY PARTICULAR PURPOSE.**

3. The Pump can only be used under the supervision of medical personnel whose skill and judgment determine the suitability of the Pump for any particular medical treatment.

4. All recommendations, information, and descriptive literature supplied by the Manufacturer or its agents are believed to be accurate and reliable, but do not constitute warranties.

E. Computer Program License:

1. The Pump is intended to be used in conjunction with a particular Licensed Computer Program supplied by Manufacturer and use of any other program or unauthorized modification of a Licensed Computer Program shall void Manufacturer’s warranty as set forth above.

2. The Original Purchaser and any users authorized by the Original Purchaser are hereby granted a nonexclusive, nontransferable license to use the Licensed Computer Program only in conjunction with the single Pump supplied by Manufacturer. The Licensed Computer Program is supplied only in machine-readable object code form and is based upon Manufacturer’s proprietary confidential information. No rights are granted under this license or otherwise to decompile, produce humanly readable copies of, reverse engineer, modify or create any derivative works based upon the Licensed Computer Program.

3. All other terms and conditions of this Limited Warranty shall apply to the Licensed Computer Program.

The Manufacturer disclaims responsibility for the suitability of the Pump for any particular medical treatment or for any medical complications resulting from the use of the Pump. The Manufacturer shall not be responsible for any incidental damages or consequential damages to property, loss of profits, or loss of use caused by any defect or malfunction of the Pump.

This warranty gives the Original Purchaser specific legal rights, and the Original Purchaser may have other legal rights which may vary from state to state.

CADD, CADD-Prizm, the CADD-Prizm design mark, and the Medication Cassette Reservoir design mark are trademarks of the Smiths Medical family of companies. The symbol ® indicates it is registered in the U.S. Patent and Trademark Office and certain other countries.

All other names and marks mentioned are the trade names, trademarks or service marks of their respective owners.

These products are covered by one or more of the following: U.S. Patent Nos. 4,559,038; 4,565,542; 4,650,469; 5,181,910; 5,338,157; 5,364,242; 5,485,408; 5,531,697; 5,531,698; 5,538,399; 5,540,561; 5,564,915; 5,567,136; 5,567,119; 5,695,473 for Model 6100 only; other patents pending.

Smiths Medical MD, Inc.
St. Paul, Minnesota 55112 U.S.A.
1 800.426.2448
+1 651.633.2556
www.smiths-medical.com

smiths

© 2004 Smiths Medical family of companies.
All rights reserved.

2004-12
40-3038-01J